



# EQUITA CONSUMER CONFERENCE 2013

Milan

6 September 2013

fuoco



aria



terra

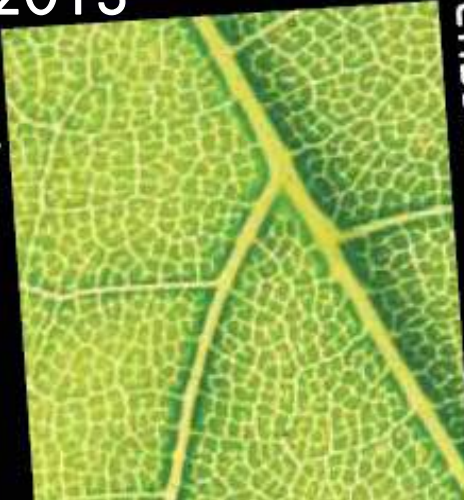

acqua



# Towards a stronger internationalization

- Sabaf enjoys a strong leadership position in Italy and Europe (market share above 40%)
- Demographic and macroeconomic trends do not leave space for substantial growth in Europe
- Sabaf market share worldwide is still low (around 10%)
- Most efforts are addressed in increasing our international presence, with special focus on:
  - Turkey
  - China
  - Brazil
  - India

# Sales by market

<i>in thousands of Euro</i>	H1 2013	H1 2012	Change %	FY 2012
Italy	24,353	25,971	-6.2%	45,597
Western Europe	3,392	4,114	-17.5%	7,337
Eastern Europe	15,015	16,014	-6.2%	33,236
Asia and Oceania	6,206	6,326	-1.9%	12,306
South America	11,769	11,989	-1.8%	21,895
Africa	5,462	3,479	+57.0%	6,950
US, Canada & Mexico	2,204	1,822	+21.0%	3,412
<b>Total</b>	<b>68,401</b>	<b>69,715</b>	<b>-1.9%</b>	<b>130,733</b>

# Analysis by market - Italy

H1 2013	H1 2012	Change %
24,353 <i>35.6%</i>	25,971 <i>37.3%</i>	-6.2%

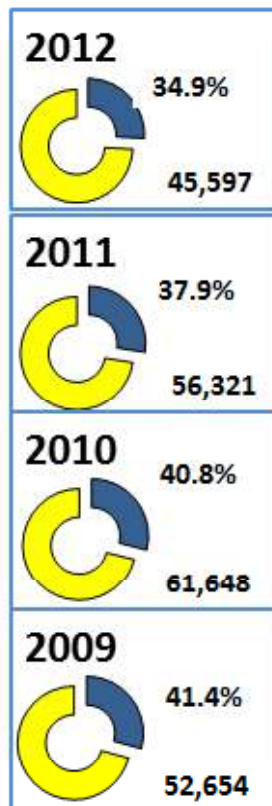

Italy - traditionally the most important appliance manufacturer in Europe - is partly losing its role

Some customers have reduced their operations in Italy, other have completed abandoned the country or stopped activity due to financial troubles

On the other side, appliance manufacturers focused on high end segments continue to perform well in international markets

Sabaf offers to domestic customers high quality, differentiated components - helping them to promote the "made in Italy" concept



# Analysis by market – Western Europe

H1 2013	H1 2012	Change %
3,392 <i>4.9%</i>	4,114 <i>5.9%</i>	-17.5%

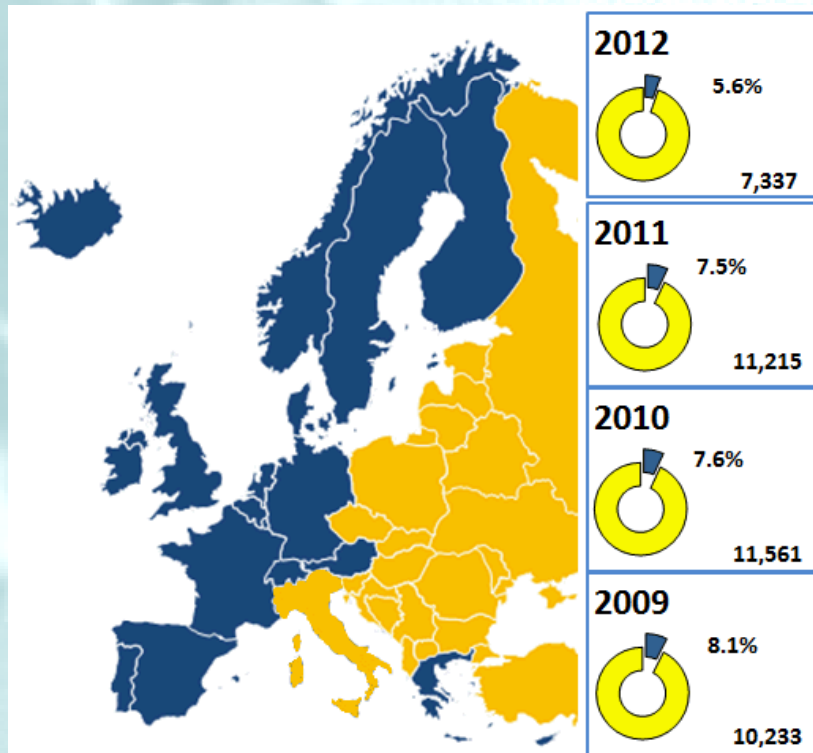

Like the Italian players, the appliance manufacturers in Western Europe risk to suffer competition from emerging countries

Sabaf plans to consolidate its customer base, relying on the quality and the constant innovation of its product range

# Analysis by market – Eastern Europe & Turkey

H1 2013	H1 2012	Change %
15,015 <i>22.0%</i>	16,014 <i>23.0%</i>	-6.2%

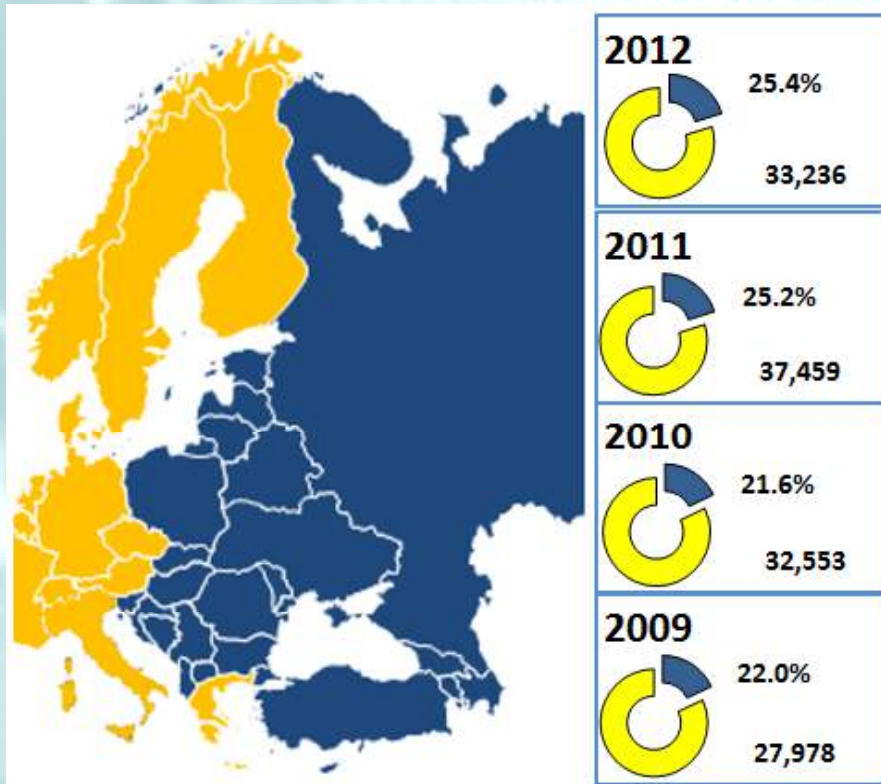

Sabaf tends to benefit from the expected growth in Eastern European countries, with a specific focus on **Turkey**, today the largest appliance manufacturer in the area

The set-up of a manufacturing plant in Turkey during 2012 and the development of new commercial relationships in this country represent key elements

# Sabaf in Turkey



A new factory has been set up  
in Manisa (near Izmir)  
built from greenfield

- € 8 mn investment, 10,000 sqm
- Production started in Q4 2012
- Manufacturing of burners dedicated to the local market, Middle East and North Africa, up to now supplied from Italy
- € 5m expected sales from the new factory in 2013 (50 people employed), already profitable
- Constant growth planned for the following years





# Analysis by market – Asia & Oceania

H1 2013	H1 2012	Change %
6,206 <i>9.1%</i>	6,326 <i>9.1%</i>	-1.9%

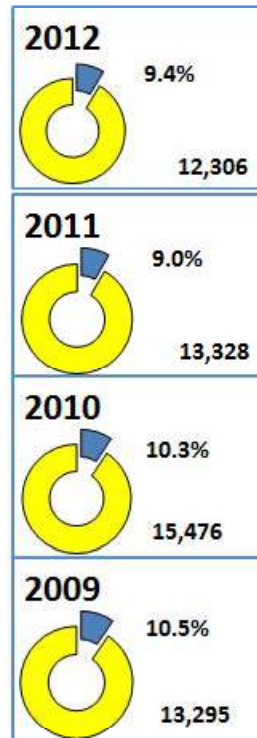

A boosting demand, along with stricter safety standards, represent growth opportunities for Sabaf

Young people tend to westernize their lifestyles, also regarding furniture and household appliances

Sabaf's universally reknown brand and "made in Italy" reading represent important premium in all the Asian markets



# Sabaf in China

- Total production: 26 mn hobs
  - Domestic market 19mn
  - Export markets 7 mn
- Expected product mix trend: higher value, moderate volume growth
- 92% of hobs consist of 2 burners and 2 valves
- Sabaf is targeting 10% premium market. Still on the table two different options
  1. Fully owned factory
  2. Joint venture with a component manufacturer
- We are holding meetings with potential counterparts

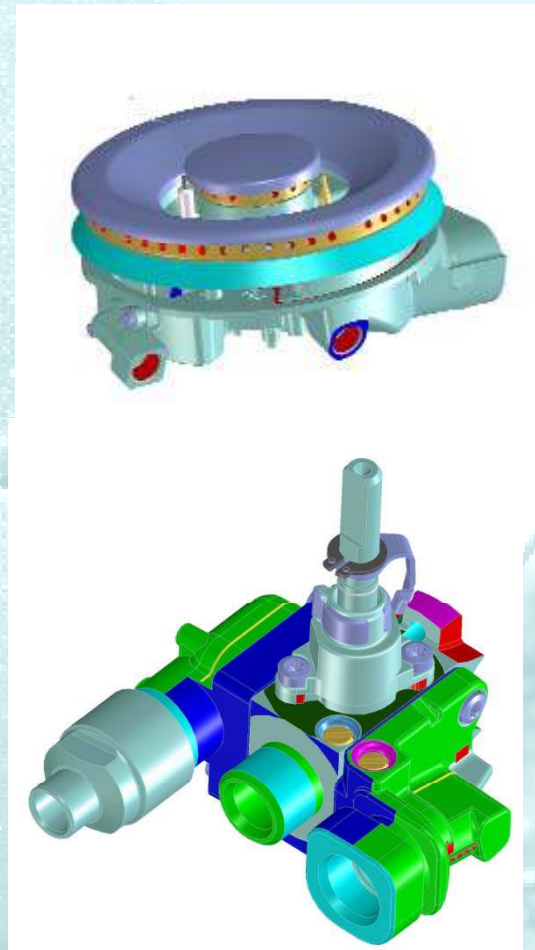

# Analysis by market – South America

H1 2013	H1 2012	Change %
11,769 <i>17.2%</i>	11,989 <i>17.2%</i>	-1.8%

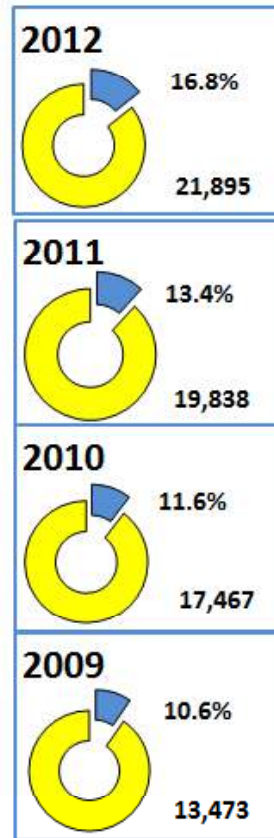

A large and fast growing market makes South America a priority in Sabaf's strategy

Sabaf's presence here is well consolidated (a factory in Brasil was set up in 2001)

Production capacity will be increased by 33% by year end, in order to meet new contracts recently won

# Analysis by market – North America & Mexico

H1 2013	H1 2012	Change %
2,204 <i>3.2%</i>	1,822 <i>2.6%</i>	<i>+21.0%</i>

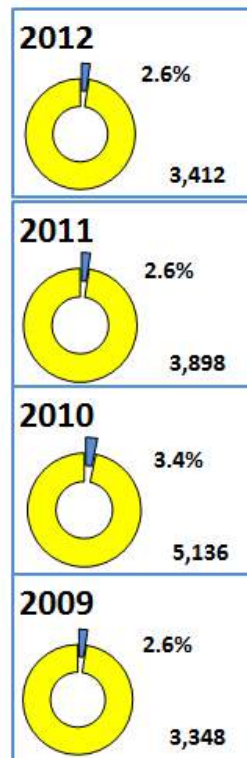

A wide range of innovative and efficient products, good commercial relationships and excellent technical reputation make Sabaf ready to exploit new opportunities in North America

Sabaf market share is constantly increasing in the growing built-in segment.

A growing focus on safety is also emerging in different market sectors (RV)



# Analysis by market - North Africa

H1 2013	H1 2012	Change %
5,462 <i>8.0%</i>	3,479 <i>5.0%</i>	<i>+57.0%</i>

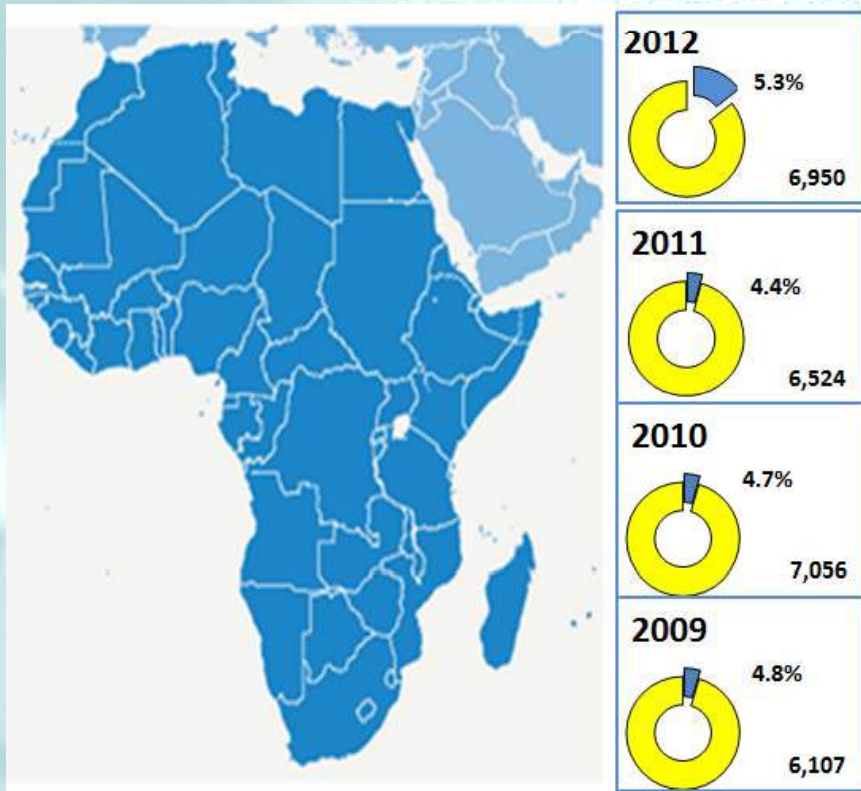

Leveraging on a strong brand reputation, geographical proximity and long-term presence, Sabaf is successfully increasing its market share in the area

Huge housing market plans for new married young people represent an opportunity in North African markets

Turmoils in Egypt are causing a substantial reduction in industrial production. We estimate €2mn lower sales in Q4 2013 compared to Q4 2012

# Sales by product line

<i>in thousands of Euro</i>	H1 2013	H1 2012	Change %	FY 2012
Brass valves	7,950	10,579	-24.9%	18,601
Light alloy valves	14,760	11,918	+23.8%	23,524
Thermostats	7,036	7,593	-7.3%	13,074
Standard burners	19,268	20,432	-5.7%	39,337
Special burners	9,957	9,970	-0.1%	18,850
Accessories	6,195	5,949	+4.1%	11,226
<i>Hinges</i>	3,235	3,274	-1.2%	6,121
<b>Total</b>	<b>68,401</b>	<b>69,715</b>	<b>-1.9%</b>	<b>130,733</b>

# Sales and profitability by quarter

QUARTERLY SALES AND EBITDA MARGIN





# Income statement

€ x 000	<u>Q2 13</u>		<u>Q1 13</u>		<u>H1 13</u>		<u>H1 12</u>		
<b>SALES</b>	<b>37,028</b>	<b>100.0%</b>	<b>31,373</b>	<b>100.0%</b>	<b>68,401</b>	<b>100.0%</b>	<b>69,715</b>	<b>100.0%</b>	<b>-1.9%</b>
Materials	(16,284)	-44.0%	(13,684)	-43.6%	(29,968)	-43.8%	(26,762)	-38.4%	
Payroll	(8,440)	-22.8%	(7,898)	-25.2%	(16,338)	-23.9%	(15,722)	-22.6%	
Change in stock	3,109	8.4%	2,896	9.2%	6,005	8.8%	115	0.2%	
Other operating costs/income	<u>(7,765)</u>	-21.0%	<u>(6,987)</u>	-22.3%	<u>(14,752)</u>	-21.6%	<u>(15,983)</u>	-22.9%	
<b>EBITDA</b>	<b><u>7,648</u></b>	<b>20.7%</b>	<b><u>5,700</u></b>	<b>18.2%</b>	<b><u>13,348</u></b>	<b>19.5%</b>	<b><u>11,363</u></b>	<b>16.3%</b>	<b>17.5%</b>
Depreciation	(3,215)	-8.7%	(3,229)	-10.3%	(6,444)	-9.4%	(6,464)	-9.3%	
Gains/losses on fixed assets	0	0.0%	0	0.0%	0	0.0%	4	0.0%	
Impairment of fixed assets	<u>(383)</u>	-1.0%	<u>0</u>	0.0%	<u>(383)</u>	-0.6%	<u>0</u>	0.0%	
<b>EBIT</b>	<b><u>4,050</u></b>	<b>10.9%</b>	<b><u>2,471</u></b>	<b>7.9%</b>	<b><u>6,521</u></b>	<b>9.5%</b>	<b><u>4,903</u></b>	<b>7.0%</b>	<b>33.0%</b>
Net financial expense	(180)	-0.5%	(159)	-0.5%	(339)	-0.5%	(541)	-0.8%	
Foreign exchange gains/losses	(45)	-0.1%	84	0.3%	39	0.1%	(96)	-0.1%	
Equity investments profits/losses	(151)	-0.4%	(138)	-0.4%	(289)	-0.4%	(197)	-0.3%	
<b>EBT</b>	<b><u>3,674</u></b>	<b>9.9%</b>	<b><u>2,258</u></b>	<b>7.2%</b>	<b><u>5,932</u></b>	<b>8.7%</b>	<b><u>4,069</u></b>	<b>5.8%</b>	<b>45.8%</b>
Income taxes	(1,025)	-2.8%	(952)	-3.0%	(1,977)	-2.9%	(1,578)	-2.3%	
Minorities	0		0		0		0		
<b>NET INCOME</b>	<b><u>2,649</u></b>	<b>7.2%</b>	<b><u>1,306</u></b>	<b>4.2%</b>	<b><u>3,955</u></b>	<b>5.8%</b>	<b><u>2,491</u></b>	<b>3.6%</b>	<b>58.8%</b>

# EBIT bridge H1 2012 - H1 2013

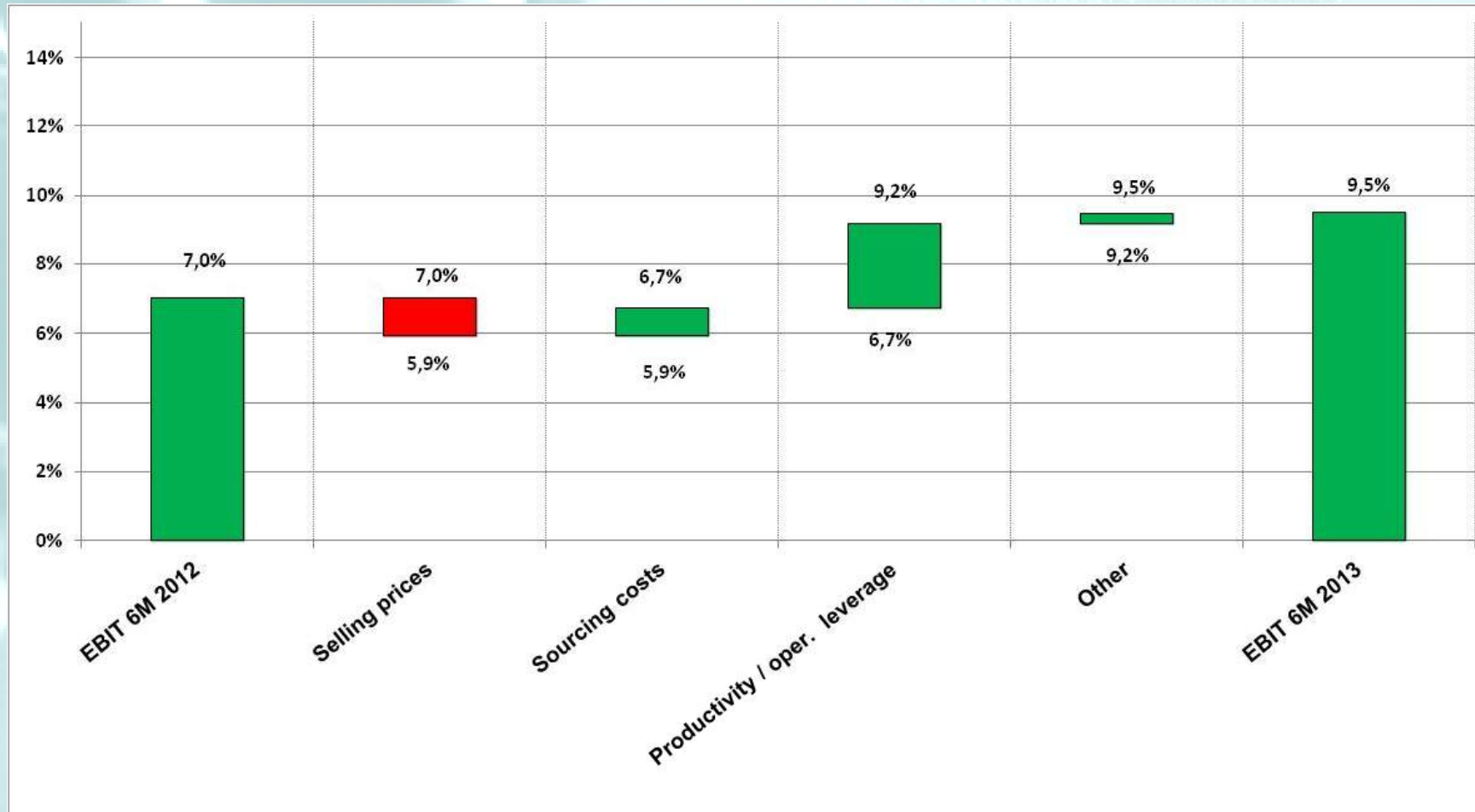

# Cash flow statement

€ x 1000	H1 13	H1 12
<i>Cash at the beginning of the period</i>	6,137	14,208
Net profit	3,955	2,491
Depreciation	6,444	6,464
Change in net working capital		
change in inventories	(5,728 )	(24 )
change in receivables	(5,968 )	790
change in payables	6,150	(4,279 )
	(5,546 )	(3,513 )
Other changes in operating items	3,029	1,170
<b>Operating cash flow</b>	<b>7,882</b>	<b>6,612</b>
Investments, net of disposals	(4,338 )	(7,366 )
<b>Free cash flow</b>	<b>3,544</b>	<b>(754)</b>
Cash flow from financial activity	(563 )	(190 )
Own shares repurchase	(890 )	(124 )
Dividends	(3,911 )	(6,900 )
Forex	(602 )	(277 )
<b>Net financial flow</b>	<b>(2,422)</b>	<b>(8,245)</b>
<i>Cash at the end of the period</i>	3,715	5,963



# Balance sheet

€ x 1000	30-Jun-13	31-Dec-12	30-Jun-12
Fixed assets	98,959	101,880	103,028
Net working capital	43,742	41,086	40,081
Short term financial assets	11	-	-
<b>Capital Employed</b>	<b>142,712</b>	<b>142,966</b>	<b>143,109</b>
Equity	112,950	115,224	116,381
Provisions for risks and severance indemnity	4,096	3,946	3,877
Net debt	25,666	23,796	22,851
<b>Sources of finance</b>	<b>142,712</b>	<b>142,966</b>	<b>143,109</b>
<b>Debt / Equity</b>	<b>0.23</b>	<b>0.21</b>	<b>0.20</b>

# Net financial position

	€ x 1000	30-Jun-13	31-Dec-12	30-Jun-12
A.	Cash	10	11	7
B.	Positive balances of unrestricted bank accounts	2,528	2,972	2,398
C.	Other liquidities	1,177	3,154	3,558
D.	<b>Cash and cash equivalents (A+B+C)</b>	<b>3,715</b>	<b>6,137</b>	<b>5,963</b>
E.	Current bank overdrafts	22,484	20,602	16,984
F.	Current portion of non-current debt	2,466	4,039	4,981
G.	Other current financial payables	11	33	47
H.	<b>Current financial debt (E+F+G)</b>	<b>24,961</b>	<b>24,674</b>	<b>22,012</b>
<b>I.</b>	<b>Current net financial debt (H-D)</b>	<b>21,246</b>	<b>18,537</b>	<b>16,049</b>
J.	Non-current bank payables	2,316	3,087	4,565
K.	Other non-current financial payables	2,104	2,172	2,237
L.	<b>Non-current financial debt (J+K)</b>	<b>4,420</b>	<b>5,259</b>	<b>6,802</b>
<b>M.</b>	<b>Net financial debt (L+I)</b>	<b>25,666</b>	<b>23,796</b>	<b>22,851</b>

# Forecasts

- In light of continued macroeconomic difficulties in Europe and socio-political instability in some of the Sabaf Group's main markets outside Europe, we remain somewhat cautious in our forecasts for the second half of the year. The lack of visibility on the order backlog and high sales volatility even in the short term are cause for further uncertainty.
- For the full year, the management confirms its forecast of an improvement in sales and profitability on 2012 levels.



# Shareholders

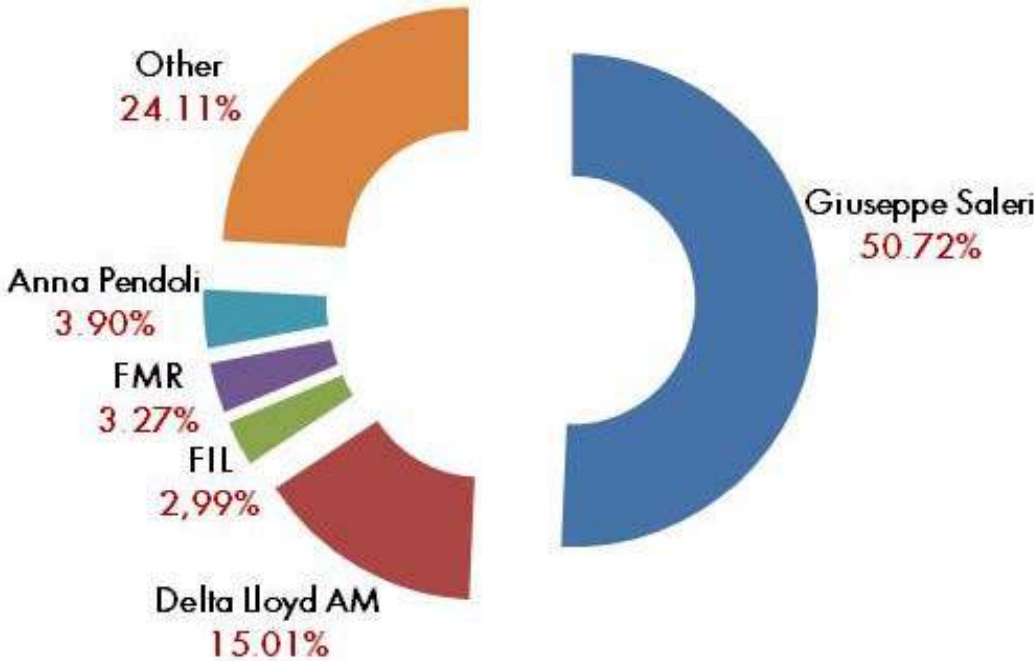

# Contact

For further information, please contact:

**Gianluca Beschi**

SABAF S.p.A.

Via dei Carpini, 1

25035 Ospitaletto (Brescia)

Tel +39.030.6843236

[gianluca.beschi@sabaf.it](mailto:gianluca.beschi@sabaf.it)

# Disclaimer

Certain information included in this document is forward looking and is subject to important risks and uncertainties that could cause actual results to differ materially.

The Company's business is in the domestic appliance industry, with special reference to the gas cooking sector, and its outlook is predominantly based on its interpretation of what it considers to be the key economic factors affecting this business. Forward-looking statements with regard to the Group's business involve a number of important factors that are subject to change, including: the many interrelated factors that affect consumer confidence and worldwide demand for durable goods; general economic conditions in the Group's markets; actions of competitors; commodity prices; interest rates and currency exchange rates; political and civil unrest; and other risks and uncertainties.

Pursuant to Article 154/2, paragraph 2 of the Italian Consolidated Finance Act (Testo Unico della Finanza), the company's Financial Reporting Officer Gianluca Beschi declares that the financial disclosure contained in this financial presentation corresponds to the company's records, books and accounting entries.