



STAR CONFERENCE

Milan

26 and 27 March 2013

fuoco



aria



terra



acqua



Towards a stronger internationalization

- Sabaf enjoys a strong leadership position in Italy and Europe (market share above 40%)
- Demographic and macroeconomic trends do not leave space for substantial growth in Europe
- Sabaf market share worldwide is still low (around 10%)
- Most efforts are addressed in increasing our international presence, with special focus on:
 - Turkey
 - China
 - Brazil
 - India

Sales by market

€ X 1000	FY 2012	FY 2011	Change %
Italy	45,597	56,321	-19.0%
Western Europe	7,337	11,215	-34.6%
Eastern Europe	33,236	37,459	-11.3%
Asia and Oceania	12,306	13,328	-7.7%
South America	21,895	19,838	10.4%
Africa	6,950	6,524	6.5%
US, Canada & Mexico	3,412	3,898	-12.5%
Total	130,733	148,583	-12.0%

Analysis by market - Italy

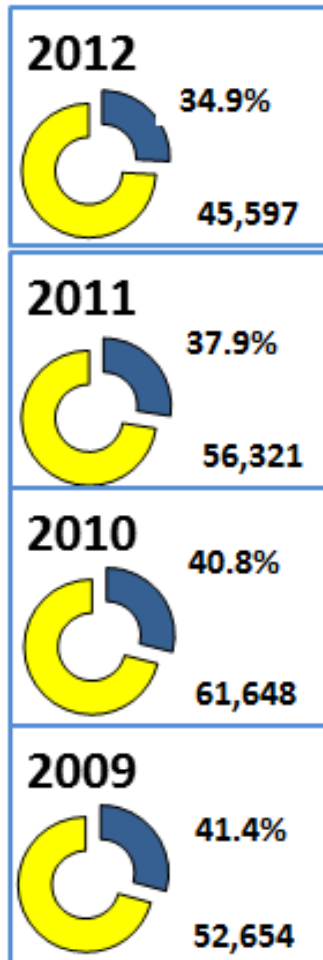

Italy - traditionally the most important appliance manufacturer in Europe - is losing its role

Some customers have reduced their operations in Italy, other have completed abandoned the country or stopped activity due to financial troubles

Sabaf - which enjoys a consolidated presence on the Italian market - offers to domestic customers product differentiation and higher energy efficiency

Analysis by market – Western Europe

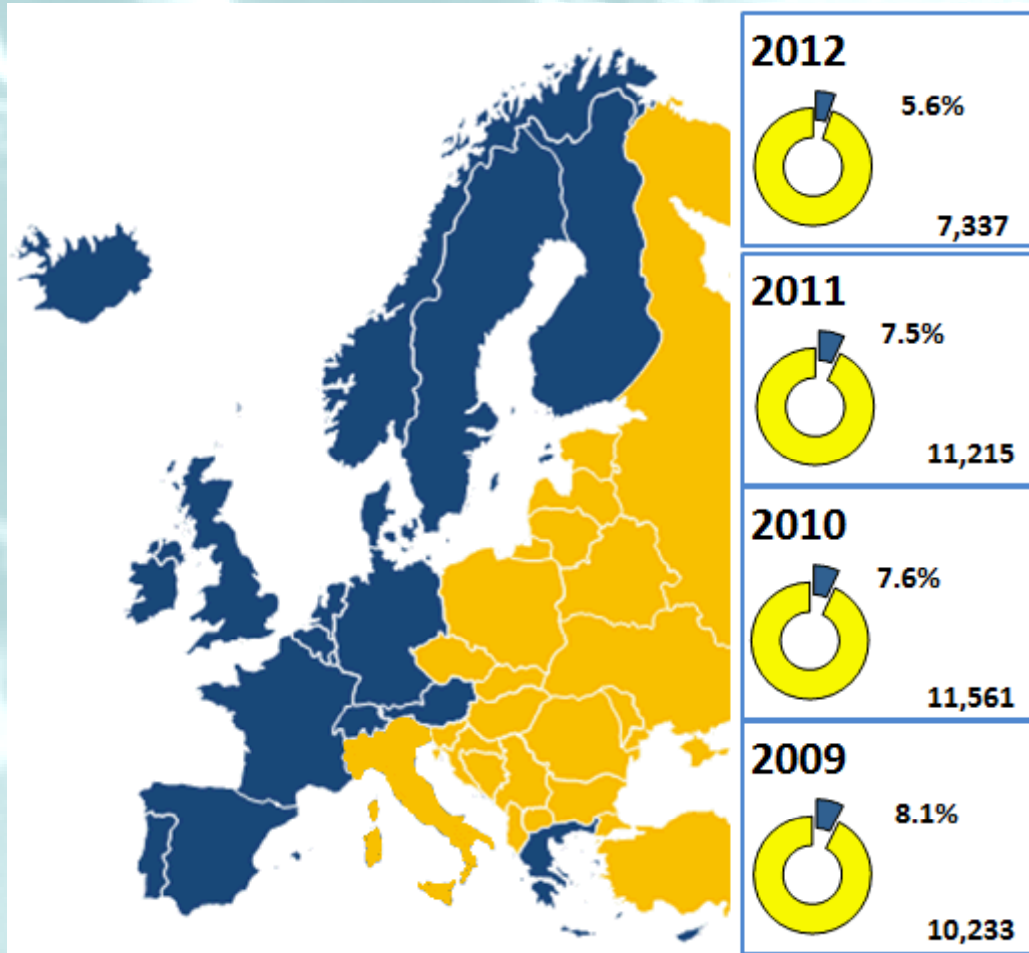

Like the Italian players, the appliance manufacturers in Western Europe risk to suffer competition from emerging countries

Sabaf plans to consolidate its customer base, relying on the quality and the constant innovation of its product range

Analysis by market – Eastern Europe & Turkey

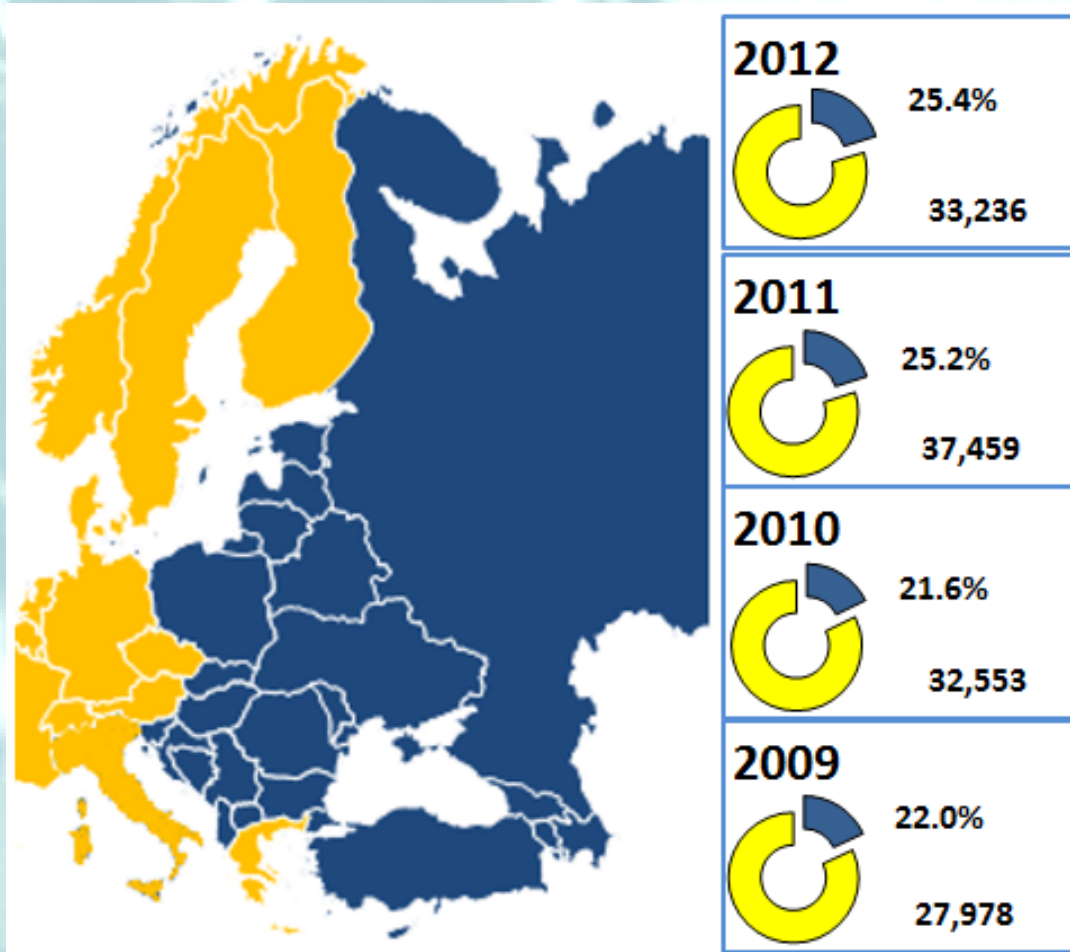

Sabaf tends to benefit from the expected growth in Eastern European countries, with a specific focus on **Turkey**, today the largest appliance manufacturer in the area

The set-up of a manufacturing plant in Turkey during 2012 and the development of new commercial relationships represent two key elements

Sabaf in Turkey



A new factory has been set up
in Manisa (near Izmir)
built from greenfield

- € 8 mn investment, 10,000 sqm
- Production started in Q4 2012
- Manufacturing of burners dedicated to the local market, Middle East and North Africa, up to now supplied from Italy
- € 5m expected sales from the new factory in 2013 (50 people employed)
- Constant growth planned for the following years



Analysis by market – Asia & Oceania

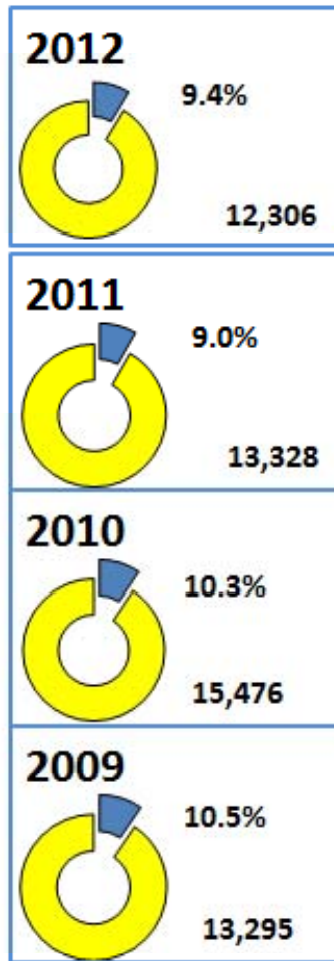

A boosting demand, along with stricter safety standards, represent growth opportunities for Sabaf

Young people tend to westernize their lifestyles, also regarding furniture and household appliances

Sabaf's universally reknown brand and "made in Italy" reading represent important premium in all the Asian markets

Sabaf in China

- Total production: 26 mn hobs
 - Domestic market 19mn
 - Export markets 7 mn
- Expected product mix trend: higher value, moderate volume growth
- 92% of hobs consist of 2 burners and 2 valves
- Sabaf is targeting 10% premium market. Still on the table three different options
 1. Fully owned factory
 2. Strategic alliance with an appliance manufacturer
 3. Acquisition/Partnership
- Today we have completed phase 1 of one to one meetings with potential counterparts

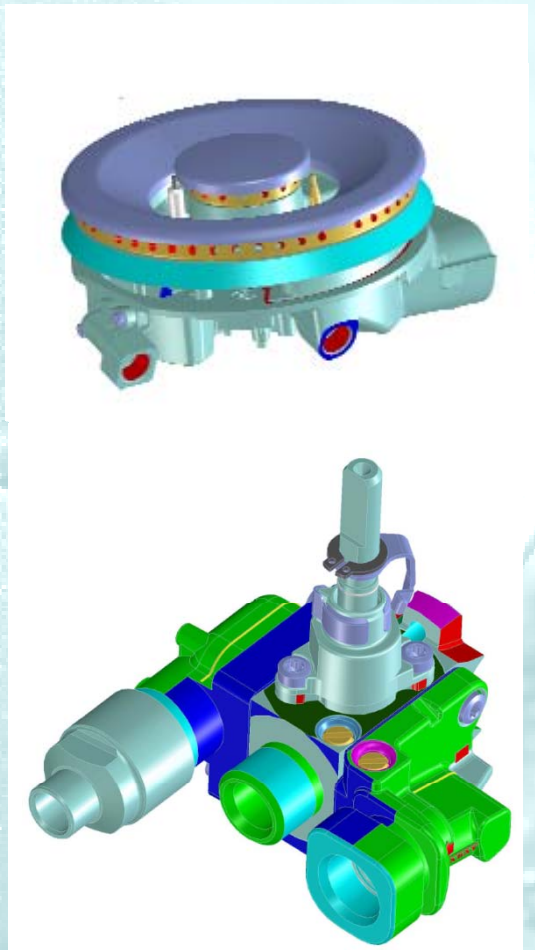

Sabaf in India

- Sabaf has developed a complete new series of gas burners especially dedicated to the Indian way of cooking
- Positive feedback from customers, currently ongoing sampling and product market test
- First sales attempts during Diwali 2013 (November)
- Major sales expected in Diwali 2014



Analysis by market – South America

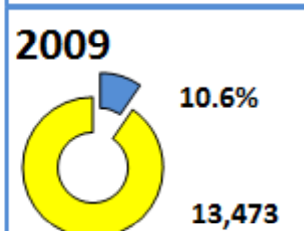
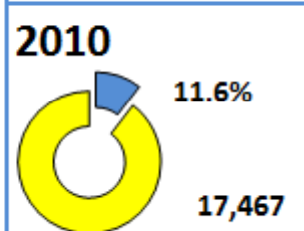
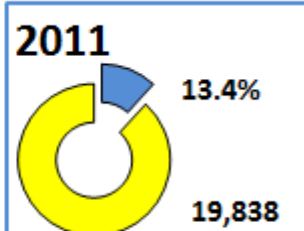
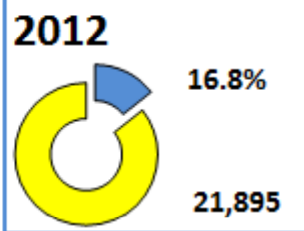

A large and fast growing market makes South America a priority in Sabaf's strategy

Sabaf's presence here is well consolidated (a factory in Brasil was set up in 2001)

Safety standards could improve, opening new opportunities

Analysis by market – North America & Mexico

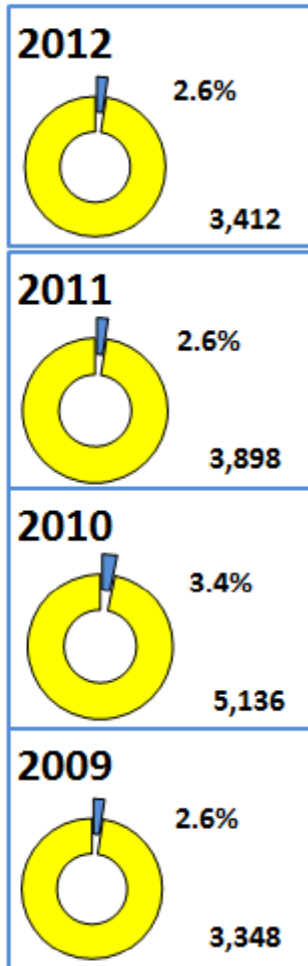

A wide range of innovative and efficient products, good commercial relationships and excellent technical reputation make Sabaf ready to exploit new opportunities in North America

Sabaf market share is constantly increasing in the growing built-in segment.

A growing focus on safety is also emerging in different market sectors (RV)

Analysis by market – North Africa

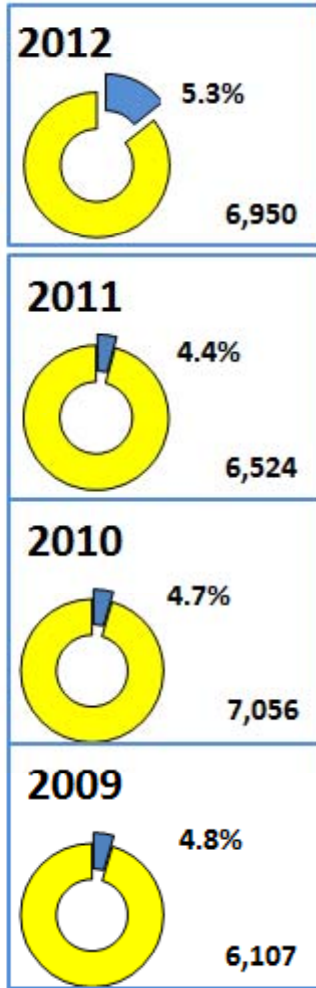

Leveraging on a strong brand reputation, geographical proximity and long-term presence, Sabaf is successfully increasing its market share in the area

Huge housing market plans for new married young people represent an opportunity in North African markets, despite the current political situation

Sales by product line

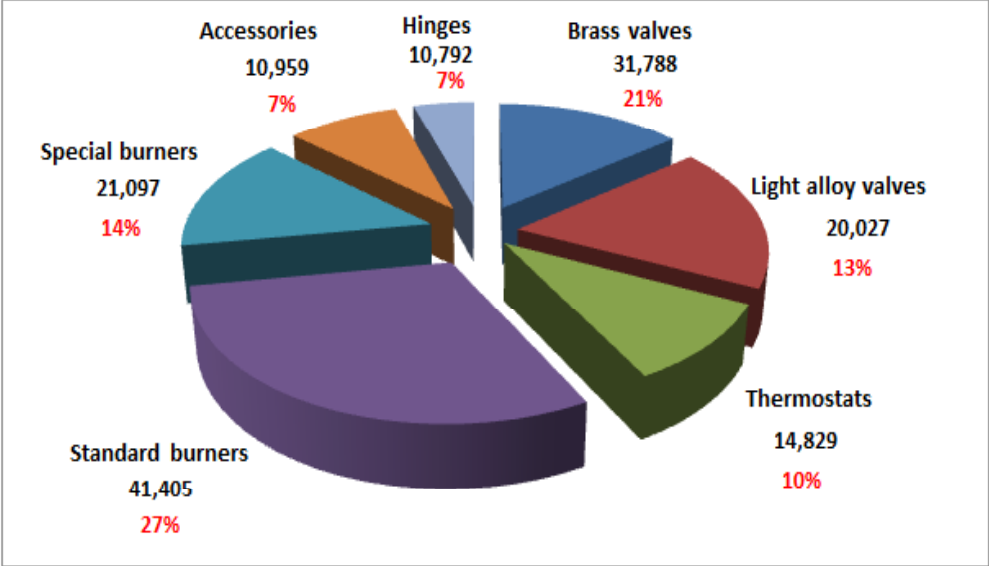

2010

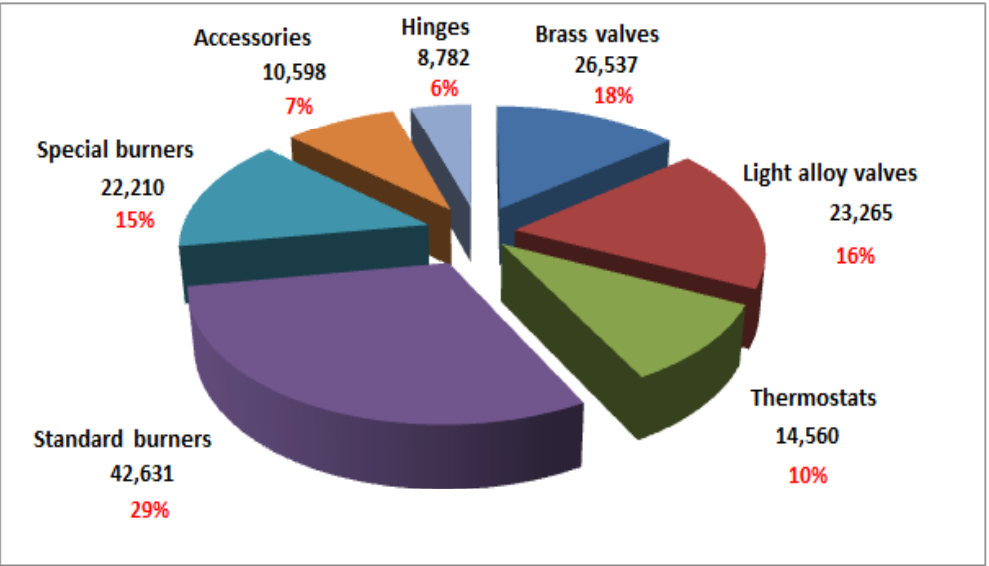

2011

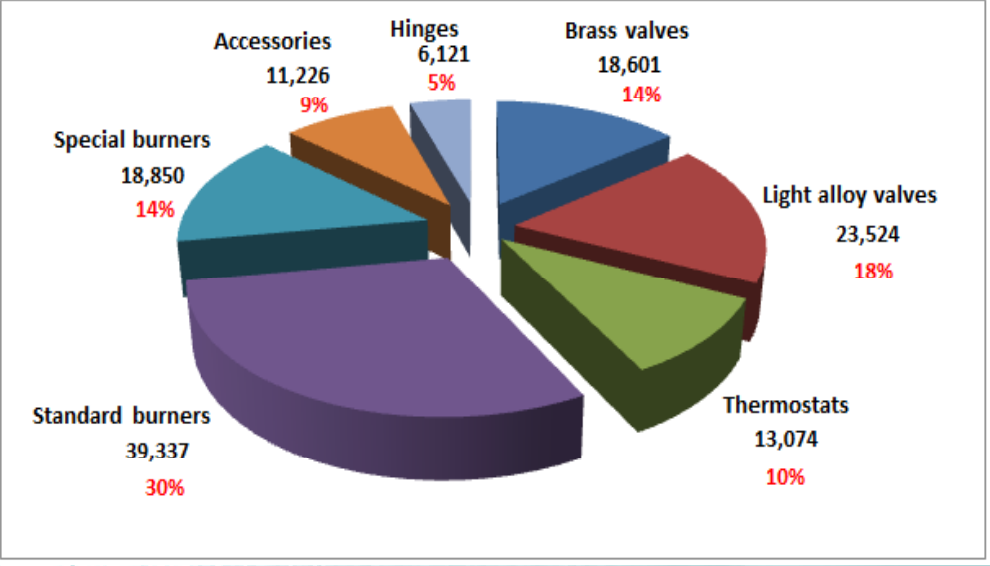

2012



Income statement

€ x 000	FY 2012		FY 2011		
SALES	130,733	100.0%	148,583	100.0%	-12.0%
Materials	(47,748)	-36.5%	(59,103)	-39.8%	
Payroll	(29,302)	-22.4%	(30,740)	-20.7%	
Change in stock	(3,174)	-2.4%	910	0.6%	
Other operating costs/income	(28,696)	-22.0%	(29,558)	-19.9%	
EBITDA	21,813	16.7%	30,092	20.3%	-27.5%
Depreciation	(12,919)	-9.9%	(12,420)	-8.4%	
Gains/losses on fixed assets	54	0.0%	23	0.0%	
Impairment of goodwill	(1,028)	-0.8%	(1,129)	-0.8%	
EBIT	7,920	6.1%	16,566	11.1%	-52.2%
Net financial expense	(943)	-0.7%	(1,146)	-0.8%	
Foreign exchange gains/losses	(293)	-0.2%	390	0.3%	
Equity investments profits/losses	(465)	-0.4%	(356)	-0.2%	
EBT	6,219	4.8%	15,454	10.4%	-59.8%
Income taxes	(2,023)	-1.5%	(4,679)	-3.1%	
Minorities	0		0		
NET INCOME	4,196	3.2%	10,775	7.3%	-61.1%
EPS	0.367		0.937		

EBIT bridge 2011 - 2012

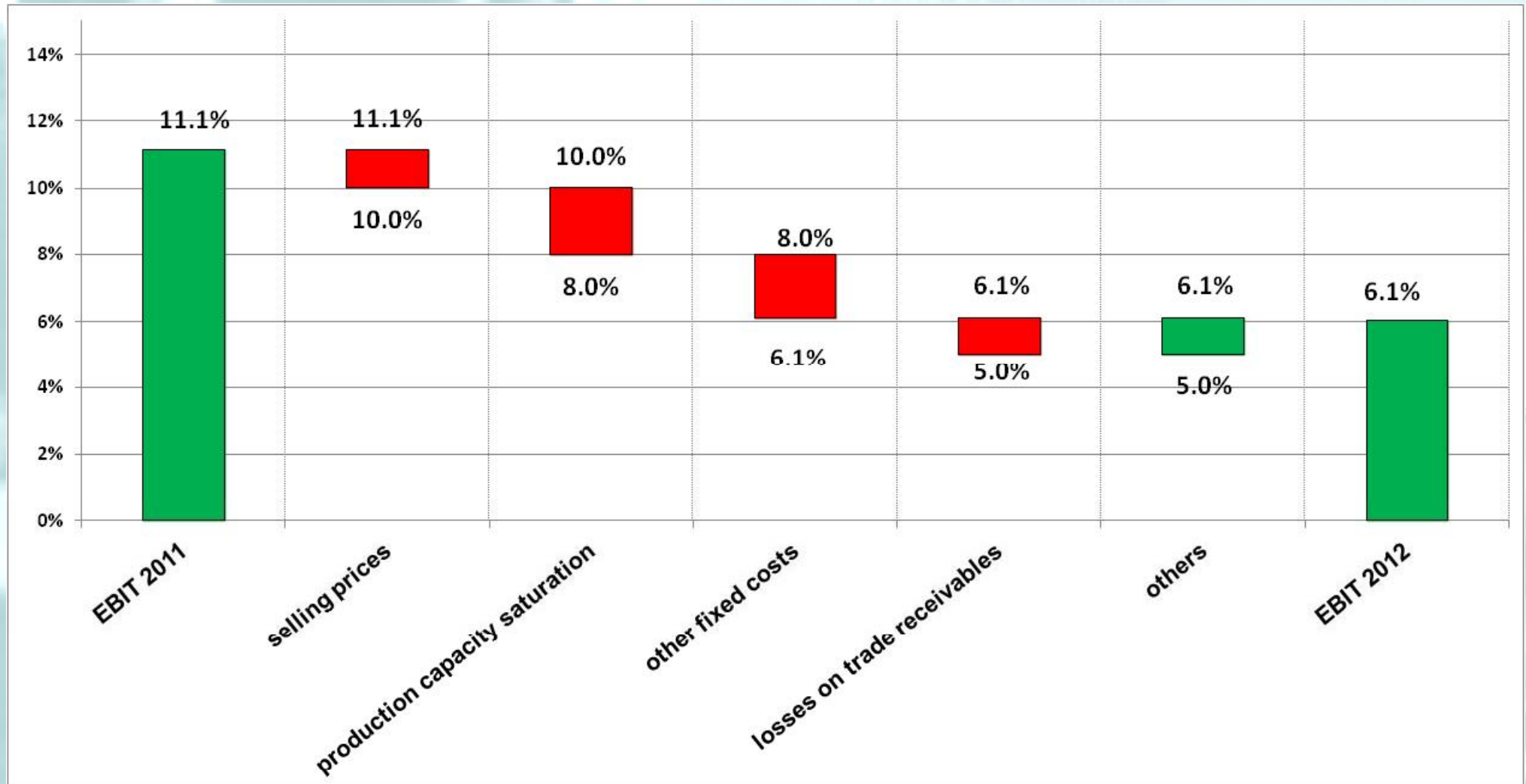

Cash flow statement

€ x 1000	FY 12	FY 11
<i>Cash at the beginning of the period</i>	14,208	9,769
Net profit	4,196	10,775
Depreciation	12,919	12,420
Change in net working capital		
change in inventories	2,847	(801)
change in receivables	4,806	981
change in payables	(9,264)	3,623
	(1,611)	3,803
Other changes in operating items	(341)	(4,559)
Operating cash flow	15,163	22,439
Investments, net of disposals	(14,316)	(14,455)
Free cash flow	847	7,984
Cash flow from financial activity	929	6,690
Own shares repurchase	(2,011)	0
Dividends	(6,900)	(9,201)
Forex	(936)	(1,034)
Cash flow	(8,071)	4,439
<i>Cash at the end of the period</i>	<i>6,137</i>	<i>14,208</i>

Balance sheet

€ x 1000	31-Dec-12	31-Dec-11
Fixed assets	101,728	102,310
Net working capital	41,086	37,915
Capital Employed	142,814	140,225
Equity	115,626	121,823
Reserves for risks and severance indemnity, deferred taxes	3,392	3,606
Net debt	23,796	14,796
Sources of finance	142,814	140,225

Net financial position

	€ x 1000	31-Dec-12	31-Dec-11
A.	Cash	11	8
B.	Positive balances of unrestricted bank accounts	2,972	11,868
C.	Other liquidities	3,154	2,332
D.	Cash and cash equivalents (A+B+C)	6,137	14,208
E.	Current bank overdrafts	20,602	8,546
F.	Current portion of non-current debt	4,039	8,486
G.	Other current financial payables	33	33
H.	Current financial debt (E+F+G)	24,674	17,065
I.	Current net financial debt (H-D)	18,537	2,857
J.	Non-current bank payables	3,087	9,051
K.	Other non-current financial payables	2,172	2,888
L.	Non-current financial debt (J+K)	5,259	11,939
M.	Net financial debt (L+I)	23,796	14,796

Forecasts

- The household appliance market in Europe continues to struggle at the start of 2013, while the outlook in other countries is encouraging.
- For FY 2013, the Group believes that it will be able to register slightly improved levels of sales and profitability compared with 2012, thanks to the greater contribution expected from markets outside Europe.

Contact

For further information, please contact:

Gianluca Beschi

SABAF S.p.A.

Via dei Carpini, 1

25035 Ospitaletto (Brescia)

Tel +39.030.6843236

gianluca.beschi@sabaf.it

Disclaimer

Certain information included in this document is forward looking and is subject to important risks and uncertainties that could cause actual results to differ materially.

The Company's business is in the domestic appliance industry, with special reference to the gas cooking sector, and its outlook is predominantly based on its interpretation of what it considers to be the key economic factors affecting this business. Forward-looking statements with regard to the Group's business involve a number of important factors that are subject to change, including: the many interrelated factors that affect consumer confidence and worldwide demand for durable goods; general economic conditions in the Group's markets; actions of competitors; commodity prices; interest rates and currency exchange rates; political and civil unrest; and other risks and uncertainties.

Pursuant to Article 154/2, paragraph 2 of the Italian Consolidated Finance Act (Testo Unico della Finanza), the company's Financial Reporting Officer Gianluca Beschi declares that the financial disclosure contained in this financial presentation corresponds to the company's records, books and accounting entries.