



HOUSEHOLD APPLIANCE DAY

London

November 20th 2012

fuoco



aria



terra



acqua



Towards a stronger internationalization

- Sabaf enjoys a strong leadership position in Italy and Europe (market share above 40%)
- Demographic and macroeconomic trends do not leave space for substantial growth in Europe
- Sabaf market share worldwide is still low (around 10%)
- Most efforts are addressed in increasing our international presence, with special focus on:
 - Turkey
 - China
 - Brazil
 - India

Sales by market



<i>€ X 1000</i>	9M 2012	9M 2011	Change %	FY 2011
Italy	34,639	43,460	-20.3%	56,321
Western Europe	5,614	8,437	-33.5%	11,215
Eastern Europe	24,819	29,350	-15.4%	37,459
Asia and Oceania	9,620	9,710	-0.9%	13,328
South America	17,111	14,694	+16.4%	19,838
Africa	5,390	4,900	+10.0%	6,524
US, Canada & Mexico	2,707	2,842	-4.8%	3,898
Total	99,900	113,393	-11.9%	148,583

Analysis by market - Italy



9M 2012

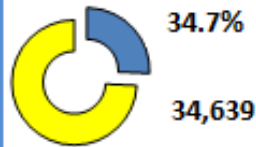

9M 2011

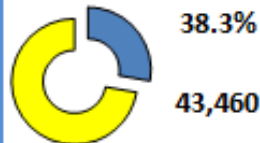

9M 2010

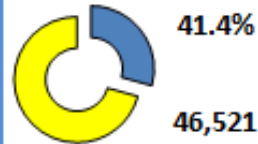

9M 2009

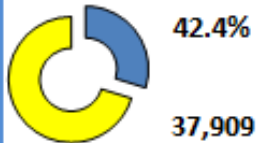

Sabaf enjoys a consolidated presence on the Italian market, leveraged by the most complete and innovative product range

Future strategies are primarily driven towards product differentiation and higher energy efficiency, to cope with a relatively stagnant market and growing pressures from emerging countries

Some traditional customers have been facing huge difficulties and have lost market share

Analysis by market – Western Europe

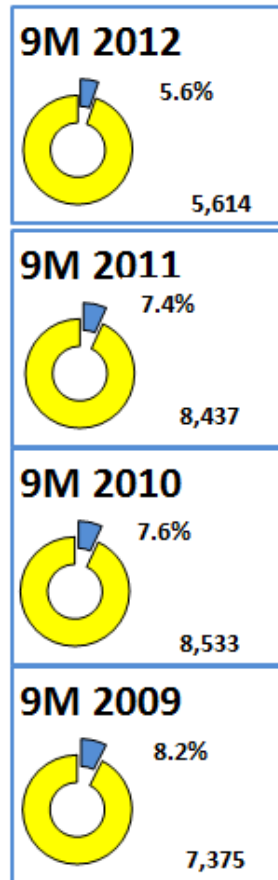

Like the Italian players, the appliance manufacturers in Western Europe risk to suffer competition from emerging countries.

Sabaf plans to consolidate its customer base, relying on the quality and the constant innovation of its product range

Analysis by market - Eastern Europe & Turkey

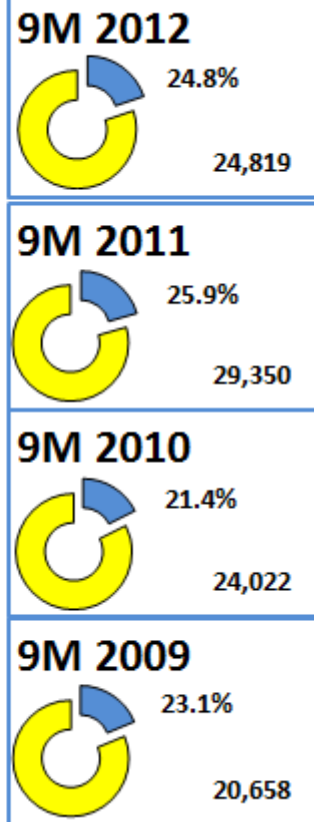

Sabaf tends to benefit from the expected growth in Eastern European countries, with a specific focus on **Turkey**, today the largest appliance manufacturer in the area

The set-up of a manufacturing plant in Turkey during 2012 and the development of new commercial relationships represent two key elements

Sabaf in Turkey



A new factory has been set up
in Manisa (near Izmir)
built from greenfield



- € 8 mn investment, 10,000 sqm
- Production starting during Q4 2012, employing 40 people
- Manufacturing of burners dedicated to the local market, Middle East and North Africa, up to now supplied from Italy
- € 5m expected sales from the new factory in 2013
- Constant growth planned for the following years

Analysis by market – Asia & Oceania

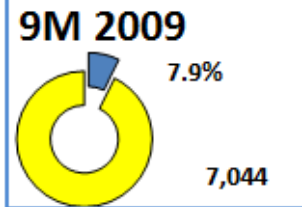
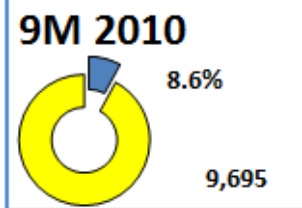
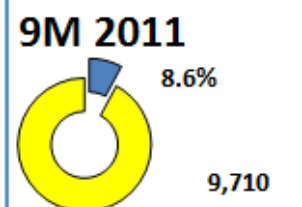
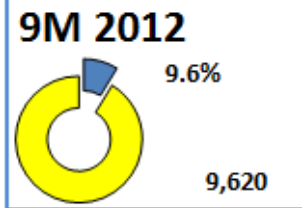

A boosting demand, along with stricter safety standards, represent growth opportunities for Sabaf

Young people tend to westernize their lifestyles, also regarding furniture and household appliances

Sabaf's universally reknown brand and "made in Italy" reading represent important premium in all the Asian markets

Sabaf in China

- Making of specific products is now complete. Positive feedback from customers
- Entry strategy is going to be decided. Different options on the table:
 - Fully owned factory
 - Strategic alliance with an appliance manufacturer
 - Acquisition
- Newsflow in the next few months

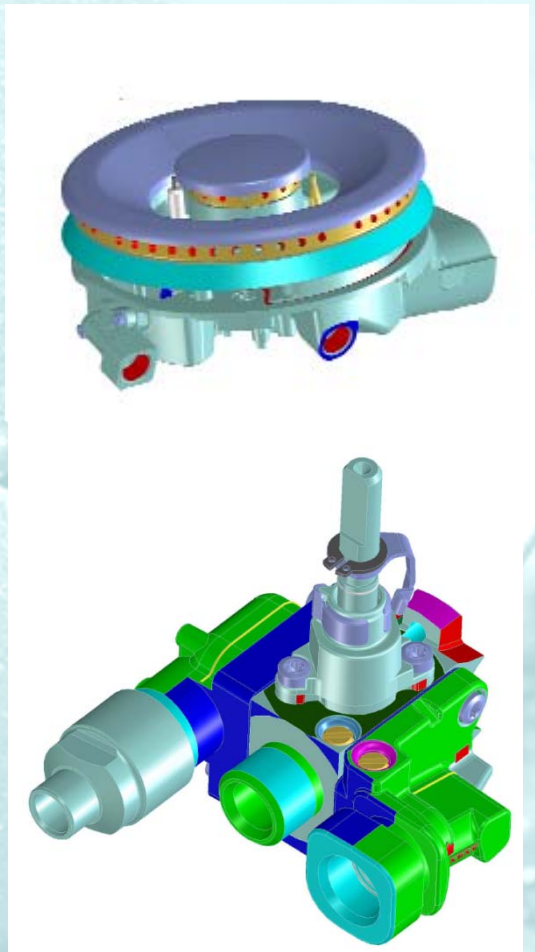

Analysis by market – South America

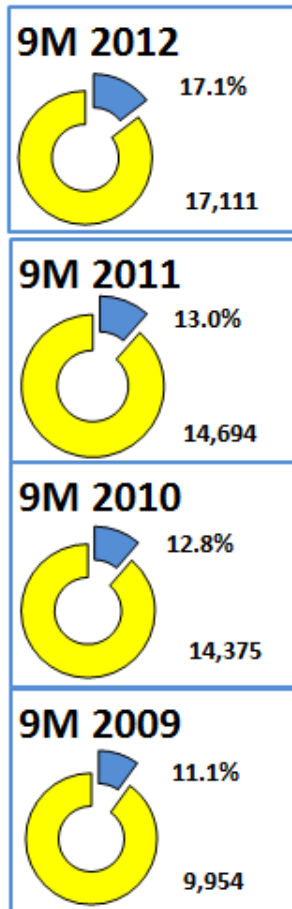

A large and fast growing market makes South America a priority in Sabaf's strategy

Sabaf's presence here is well consolidated (a factory in Brasil was set up in 2001)

Safety standards could improve, opening new opportunities

Analysis by market - North America & Mexico

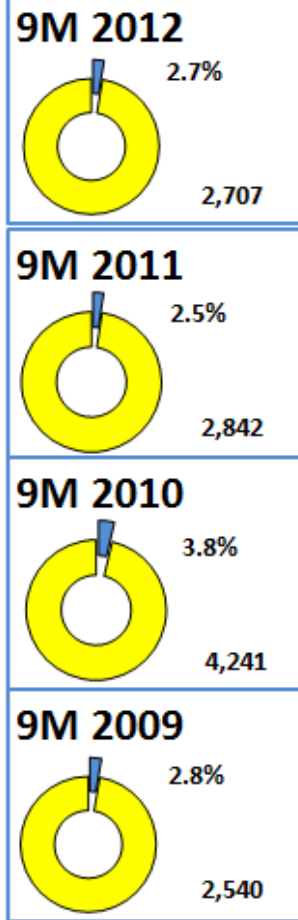

A wide range of innovative and efficient products, good commercial relationships and excellent technical reputation make Sabaf ready to exploit new opportunities in North America

A growing focus on safety is also emerging

Analysis by market – Africa

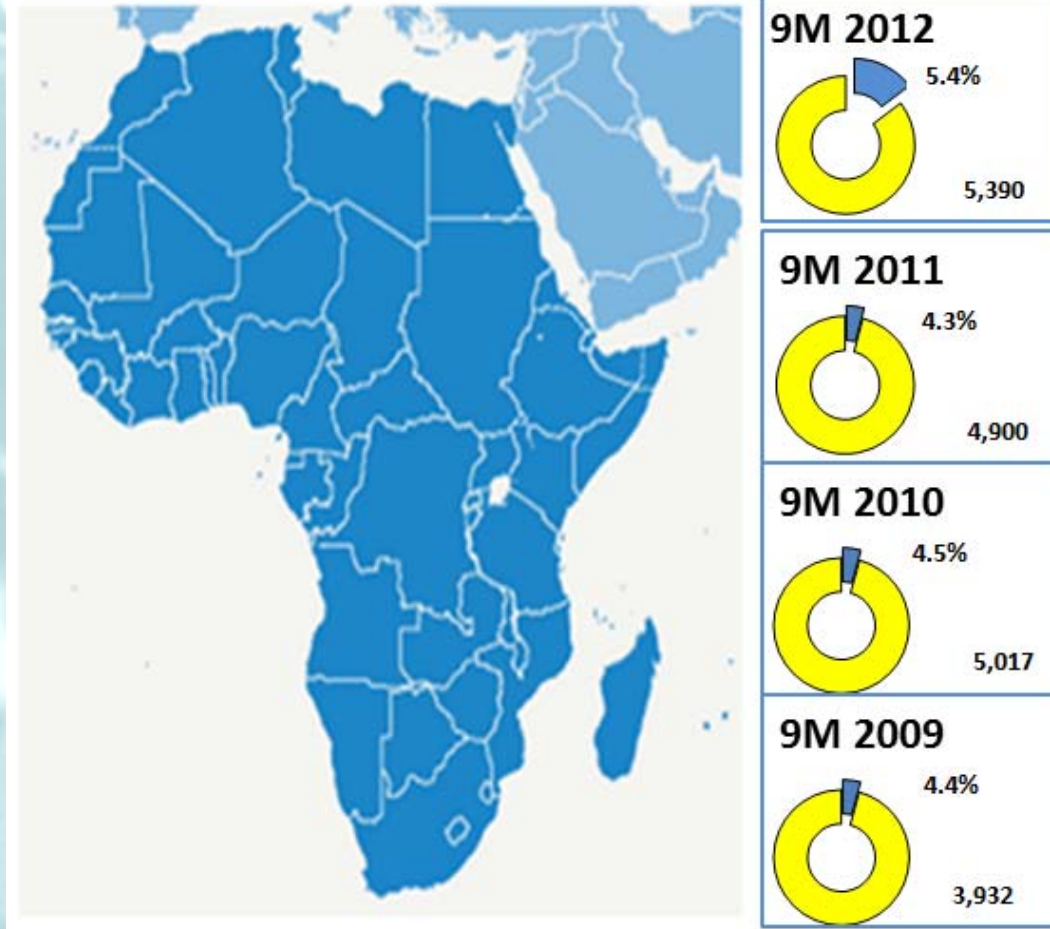

Huge housing market plans for new married young people represent an opportunity in North African markets, as soon as the political situation stabilizes.

Leveraging on geographical proximity and long-term presence, Sabaf targets to increase its market share in the area

Sales by product line

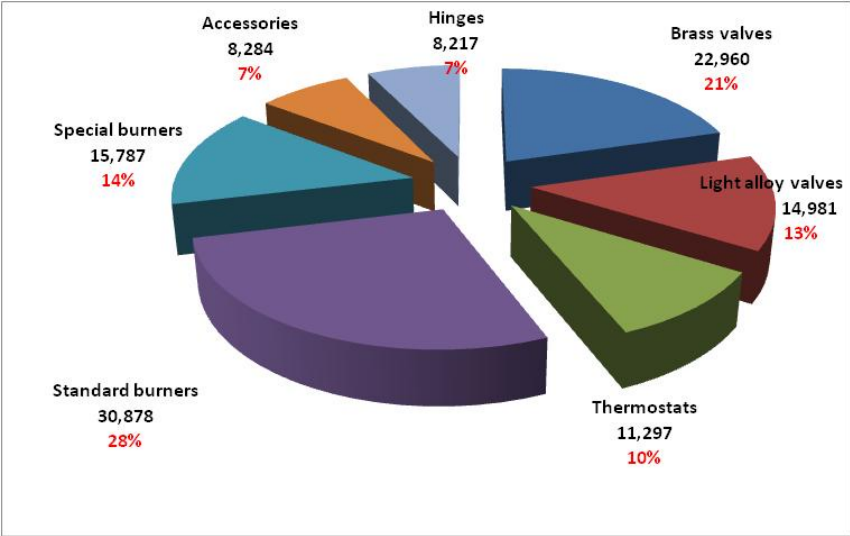

9M 2010

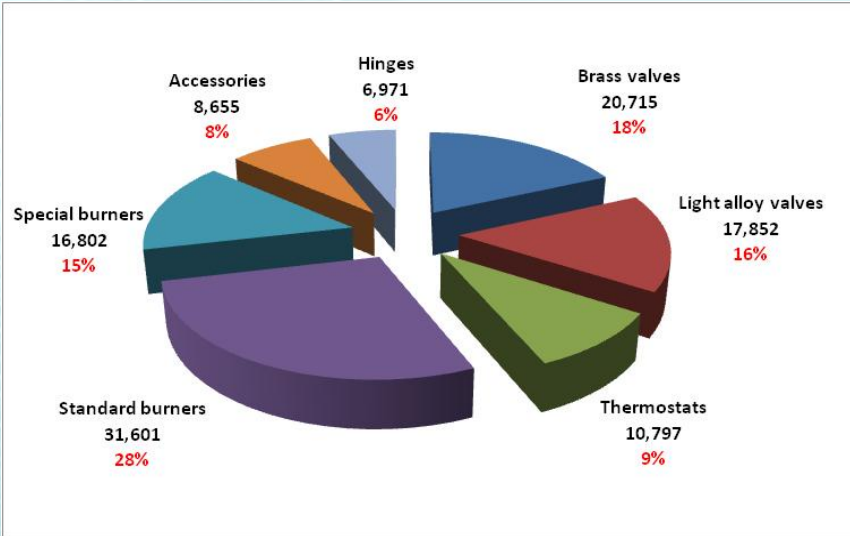

9M 2011

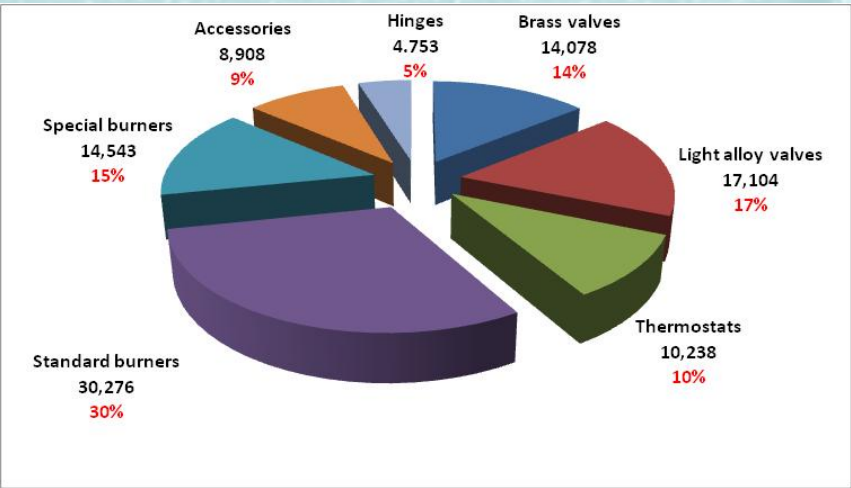

9M 2012



The Hinges unit

- The environment in which the Hinges unit operates has become progressively more difficult, following a decline on the core market and growing competitive pressure on standard products.
- As a priority, this business should be relaunched via the development of new products able to provide extra benefits (for example, the soft closing and/or opening of the oven door).
- If these initiatives are unsuccessful, we cannot rule out the need for further write-downs of the value of assets allocated to the Hinges business.

Income statement

€ x 000	<u>9M 2012</u>		<u>9M 2011</u>			<u>FY 2011</u>	
SALES	99,900	100.0%	113,393	100.0%	-11.9%	148,583	100.0%
Materials	(37,378)	-37.4%	(45,710)	-40.3%		(59,103)	-39.8%
Payroll	(22,333)	-22.4%	(23,107)	-20.4%		(30,740)	-20.7%
Change in stock	(713)	-0.7%	1,621	1.4%		910	0.6%
Other operating costs/income	(22,549)	-22.6%	(22,325)	-19.7%		(29,558)	-19.9%
EBITDA	16,927	16.9%	23,872	21.1%	-29.1%	30,092	20.3%
Depreciation	(9,621)	-9.6%	(9,318)	-8.2%		(12,420)	-8.4%
Gains/losses on fixed assets	(27)	0.0%	4	0.0%		23	0.0%
Impairment of goodwill	0	0.0%	0	0.0%		(1,129)	-0.8%
EBIT	7,279	7.3%	14,558	12.8%	-50.0%	16,566	11.1%
Net financial expense	(756)	-0.8%	(895)	-0.8%		(1,146)	-0.8%
Foreign exchange gains/losses	(218)	-0.2%	220	0.2%		390	0.3%
Equity investments profits/losses	(320)	-0.3%	(261)	-0.2%		(356)	-0.2%
EBT	5,985	6.0%	13,622	12.0%	-56.1%	15,454	10.4%
Income taxes	(2,350)	-2.4%	(4,481)	-4.0%		(4,679)	-3.1%
Minorities	0		0			0	
NET INCOME	3,635	3.6%	9,141	8.1%	-60.2%	10,775	7.3%

Cash flow statement

€ x 1000	9M 2012	9M 2011	FY 11
<i>Cash at the beginning of the period</i>	14,208	9,769	9,769
Net profit	3,635	9,141	10,775
Depreciation	9,621	9,318	12,420
Change in net working capital			
change in inventories	793	(1,120)	(801)
change in receivables	4,932	(1,450)	981
change in payables	(7,878)	(1,352)	3,623
	(2,153)	(3,922)	3,803
Other changes in operating items	112	(1,959)	(4,559)
Operating cash flow	11,215	12,578	22,439
Investments, net of disposals	(11,447)	(10,384)	(14,455)
Free cash flow	(232)	2,194	7,984
Cash flow from financial activity	(164)	4,852	6,690
Own shares repurchase	(944)	0	0
Dividends	(6,900)	(9,201)	(9,201)
Forex	(529)	(1,224)	(1,034)
Cash flow	(8,769)	(3,379)	4,439
<i>Cash at the end of the period</i>	<i>5,439</i>	<i>6,390</i>	<i>14,208</i>

Balance sheet

€ x 1000	30-Sep-12	31-Dec-11	30-Sep-11
Fixed assets	103,815	102,310	100,421
Net working capital	39,652	37,915	43,709
Capital Employed	143,467	140,225	144,130
Equity	116,590	121,823	119,718
Deferred taxes	370	366	341
Reserves for risks and severance indemnity	3,106	3,240	3,296
Net debt	23,401	14,796	20,775
Sources of finance	143,467	140,225	144,130

Net financial position

<i>€ x 1000</i>		30-Sep-12	31-Dec-11	30-Sep-11
A.	Cash	7	8	8
B.	Positive balances of unrestricted bank accounts	2,084	11,868	3,902
C.	Other liquidities	3,345	2,332	2,480
D.	Cash and cash equivalents (A+B+C)	5,436	14,208	6,390
E.	Current bank overdrafts	18,031	8,546	8,995
F.	Current portion of non-current debt	4,698	8,486	5,971
G.	Other current financial payables	46	33	32
H.	Current financial debt (E+F+G)	22,775	17,065	14,998
I.	Current net financial debt (H-D)	17,339	2,857	8,608
J.	Non-current bank payables	3,860	9,051	8,954
K.	Other non-current financial payables	2,205	2,888	3,213
L.	Non-current financial debt (J+K)	6,065	11,939	12,167
M.	Net financial debt (L+I)	23,404	14,796	20,775

Forecasts

- In light of the ongoing uncertainty in demand, the management forecasts sales of €132 million for the full year, 12% lower than in 2011 (previous forecasts pointed to a drop of 10%).
- Stripping out non-recurring items, the EBIT margin for the full year is expected to be in line with that of the first nine months, at 7.3%
- The Group is currently negotiating with its main clients for 2013; at this time, it's not possible to make quantity forecasts for the next year.

Contact

For further information, please contact our Investor Relations Department

Gianluca Beschi

SABAF S.p.A.

Via dei Carpini, 1

25035 Ospitaletto (Brescia)

Tel +39.030.6843236

gianluca.beschi@sabaf.it

Disclaimer

Certain information included in this document is forward looking and is subject to important risks and uncertainties that could cause actual results to differ materially.

The Company's business is in the domestic appliance industry, with special reference to the gas cooking sector, and its outlook is predominantly based on its interpretation of what it considers to be the key economic factors affecting this business. Forward-looking statements with regard to the Group's business involve a number of important factors that are subject to change, including: the many interrelated factors that affect consumer confidence and worldwide demand for durable goods; general economic conditions in the Group's markets; actions of competitors; commodity prices; interest rates and currency exchange rates; political and civil unrest; and other risks and uncertainties.

Pursuant to Article 154/2, paragraph 2 of the Italian Consolidated Finance Act (Testo Unico della Finanza), the company's Financial Reporting Officer Gianluca Beschi declares that the financial disclosure contained in this financial presentation corresponds to the company's records, books and accounting entries.