



London
October 2nd 2012

fuoco



aria



terra

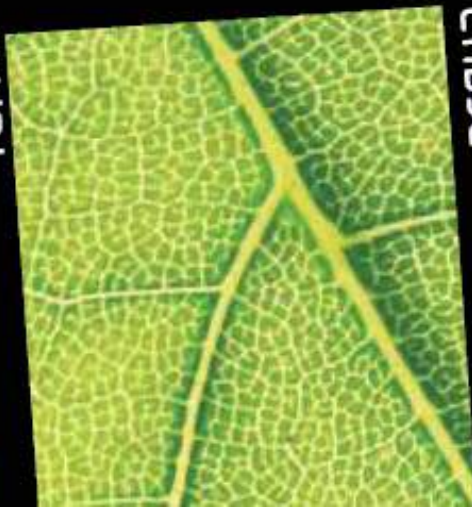

acqua



Towards a stronger internationalization

- Sabaf enjoys a strong leadership position in Italy and Europe (market share above 40%)
- Demographic and macroeconomic trends do not leave space for substantial growth in Europe
- Sabaf market share worldwide is still low (around 10%)
- Most efforts are addressed in increasing our international presence, with special focus on:
 - Turkey
 - China
 - Brazil
 - India

Sales by market

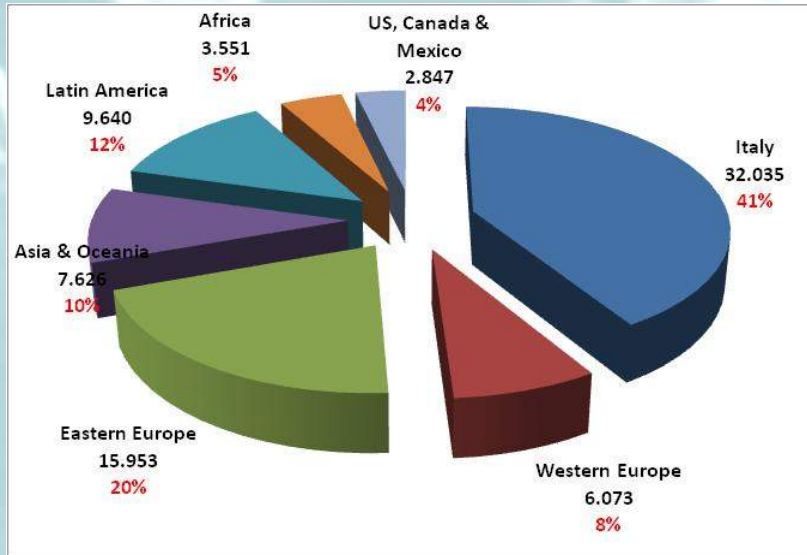

1H 2010

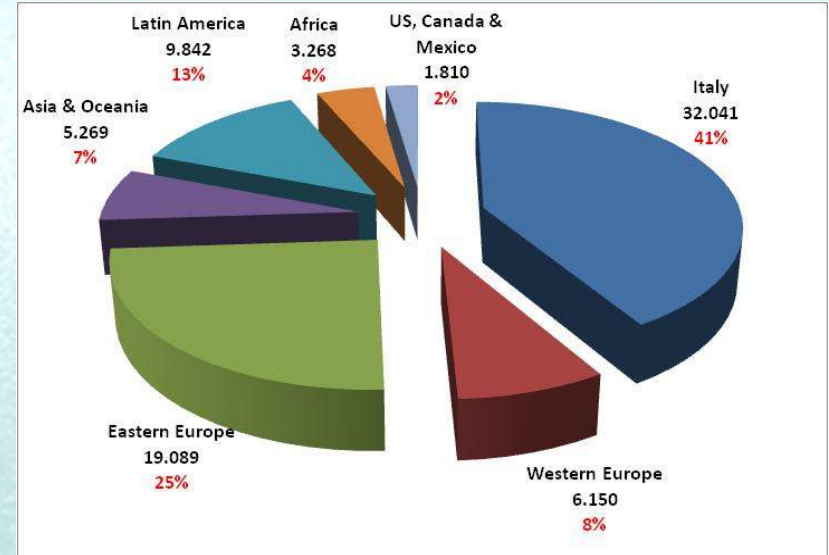

1H 2011

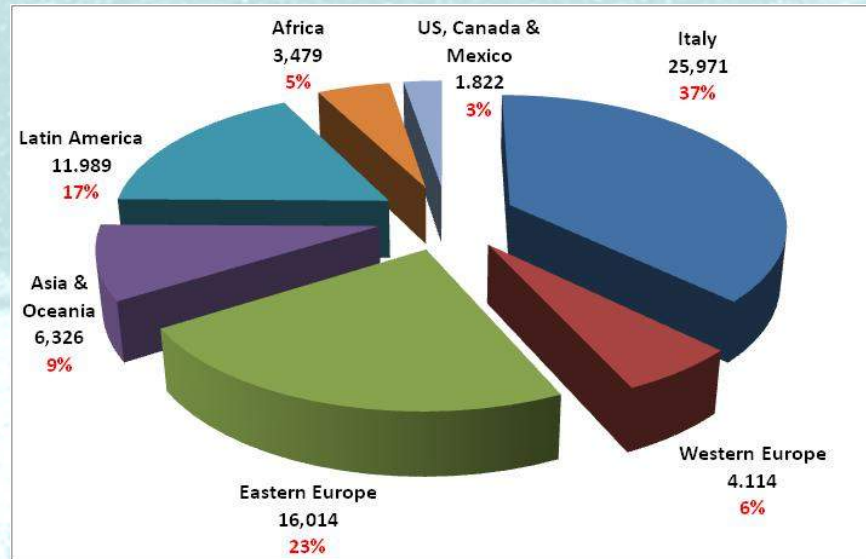

1H 2012

Analysis by market - Italy

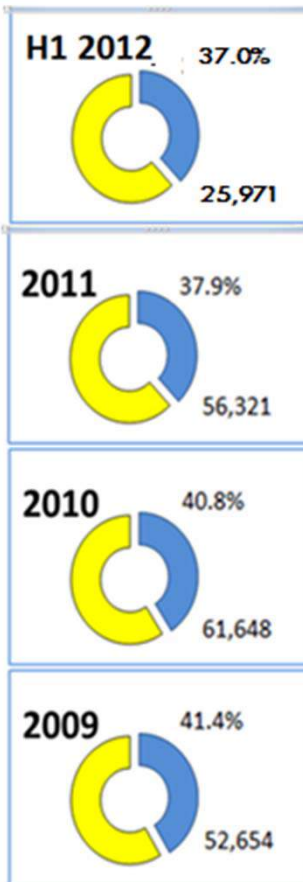

Sabaf enjoys a consolidated presence on the Italian market, leveraged by the most complete and innovative product range

Future strategies are primarily driven towards product differentiation and higher energy efficiency, to cope with a relatively stagnant market and growing pressures from emerging countries

Some traditional customers have been facing huge difficulties and have lost market share

Analysis by market – Western Europe

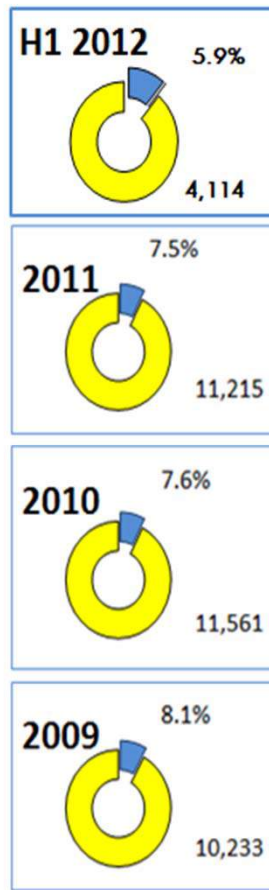

Like the Italian players, the appliance manufacturers in Western Europe risk to suffer competition from emerging countries.

Sabaf plans to consolidate its customer base, relying on the quality and the constant innovation of its product range

Analysis by market – Eastern Europe & Turkey

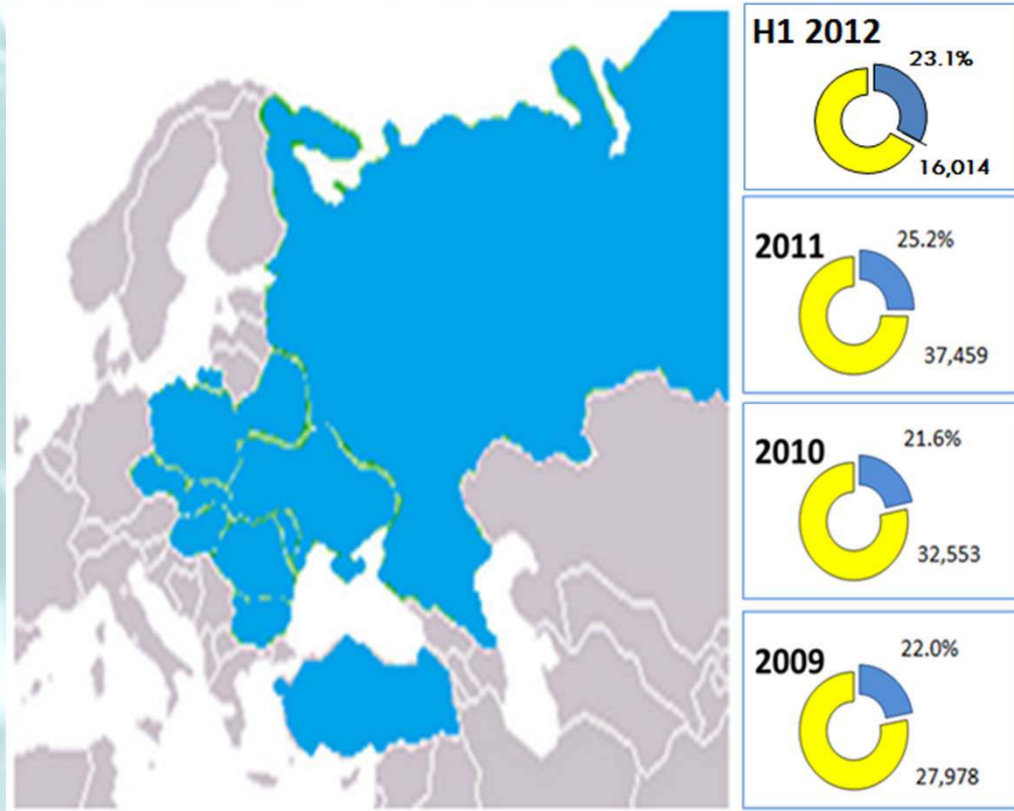

Sabaf tends to benefit from the expected growth in Eastern European countries, with a specific focus on **Turkey**, today the largest appliance manufacturer in the area. The set-up of a manufacturing plant in Turkey during 2012 and the development of new commercial relationships represent two key elements.

Sabaf in Turkey



A new factory has been set up
in Manisa (near Izmir)
built from greenfield

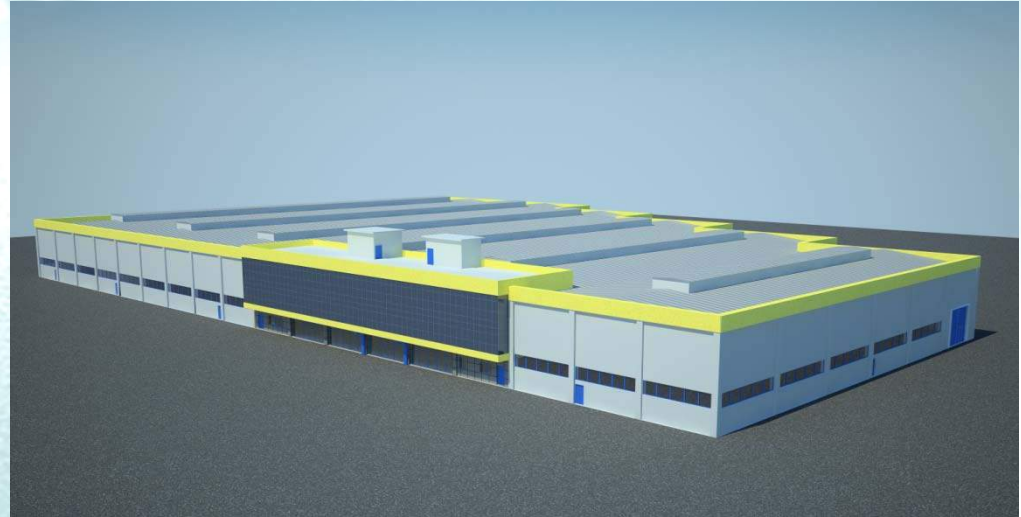

- € 8 mn investment, 10,000 sqm
- Production starting during Q4 2012, employing 40 people
- Manufacturing of burners dedicated to the local market, Middle East and North Africa, up to now supplied from Italy
- € 5m expected sales from the new factory in 2013
- Constant growth planned for the following years

Analysis by market – Asia & Oceania

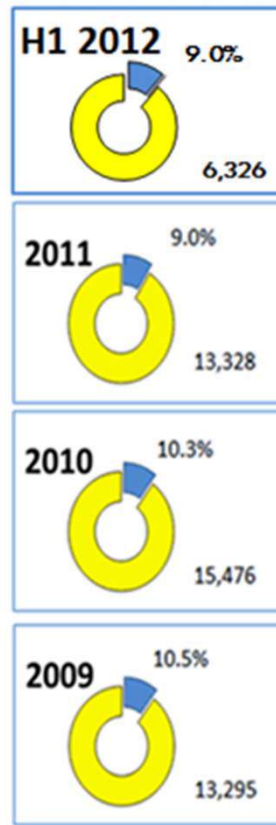

A boosting demand, along with stricter safety standards, represent growth opportunities for Sabaf

Young people tend to westernize their lifestyles, also regarding furniture and household appliances

Sabaf's universally reknown brand and "made in Italy" reading represent important premium in all the Asian markets

Sabaf in China

- Making of specific products is now complete. Positive feedback from customers
- Entry strategy is going to be decided. Different options on the table:
 - Fully owned factory
 - Strategic alliance with an appliance manufacturer
 - Acquisition
- Newsflow in the next few months

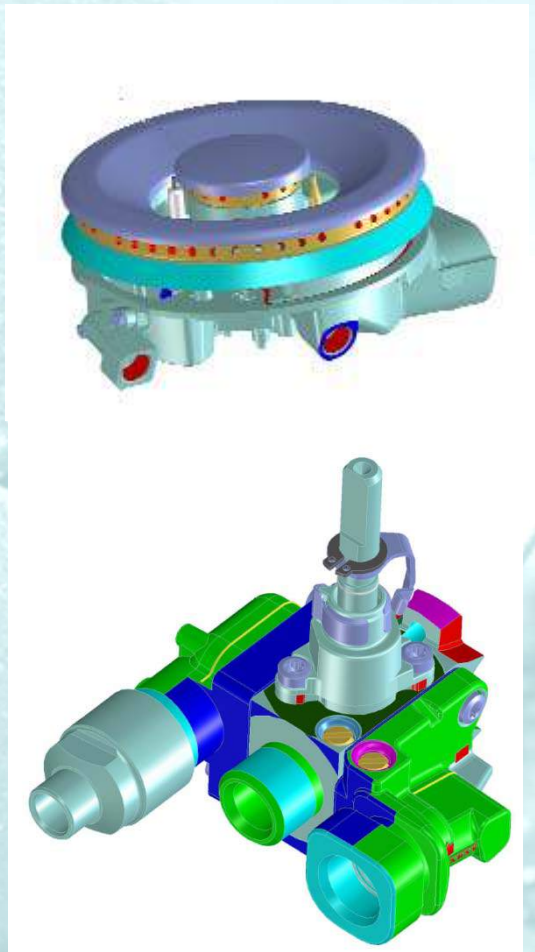

Analysis by market – South America

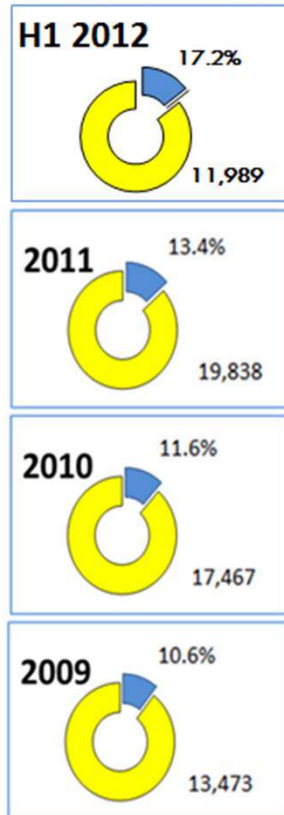

A large and fast growing market makes South America a priority in Sabaf's strategy

Sabaf's presence here is well consolidated (a factory in Brasil was set up in 2001)

Safety standards could improve, opening new opportunities

Analysis by market – North America & Mexico

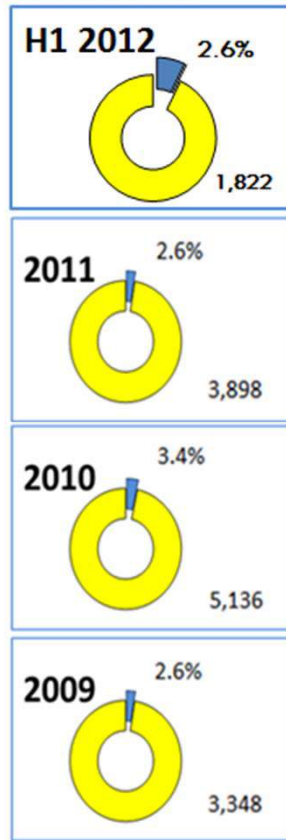

A wide range of innovative and efficient products, good commercial relationships and excellent technical reputation make Sabaf ready to exploit new opportunities in North America

A growing focus on safety is also emerging

Analysis by market – Africa

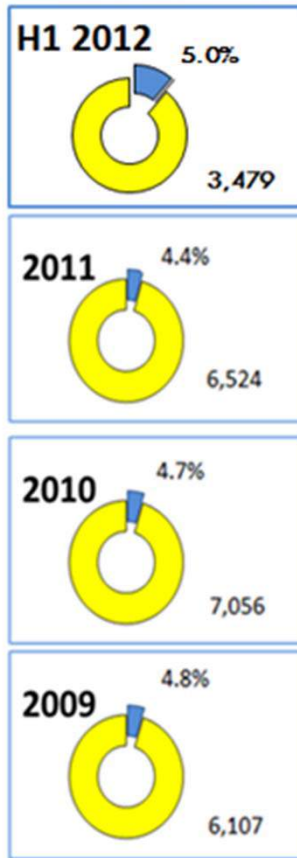

Huge housing market plans for new married young people represent an opportunity in North African markets, as soon as the political situation stabilizes. Leveraging on geographical proximity and long-term presence, Sabaf targets to increase its market share in the area

Sales by product line

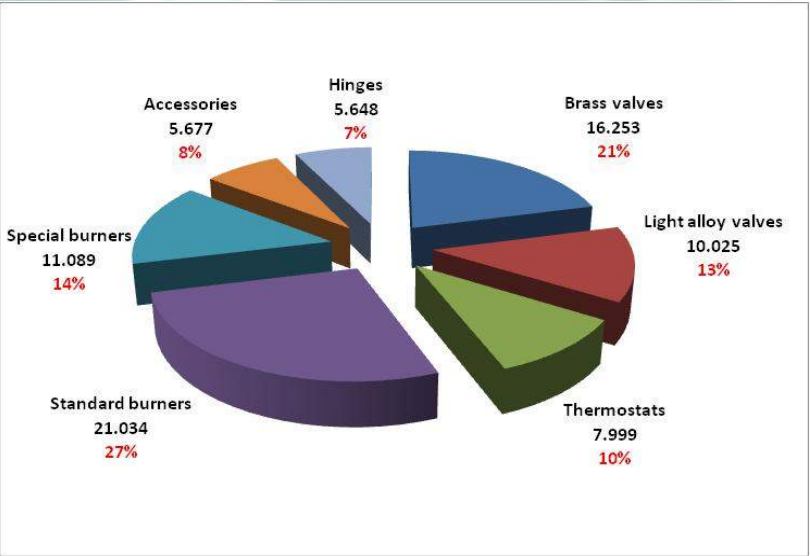

1H 2010

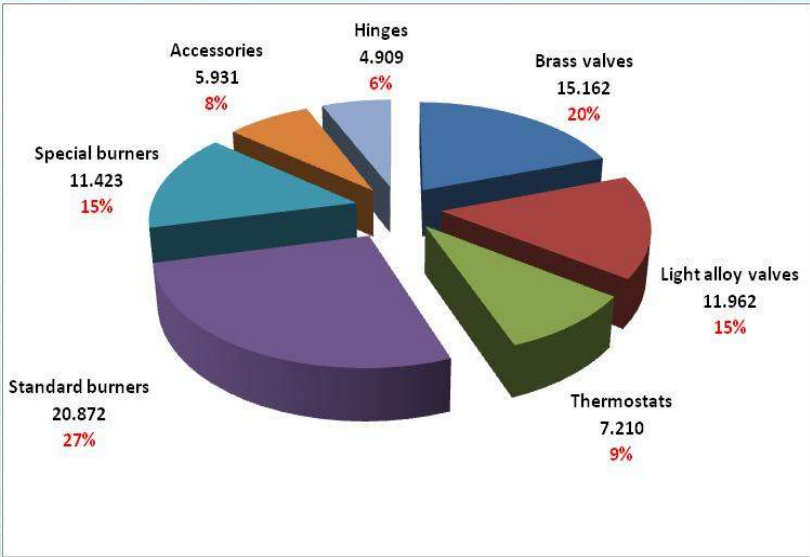

1H 2011

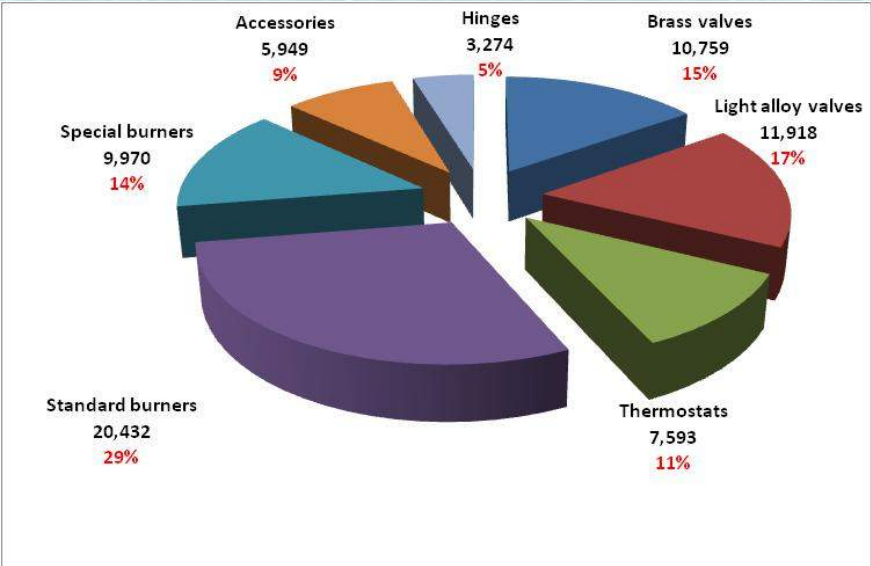

1H 2012



The Hinges unit

- The environment in which the Hinges unit operates has become progressively more difficult, following a decline on the core market and growing competitive pressure on standard products.
- As a priority, this business should be relaunched via the development of new products able to provide extra benefits (for example, the soft closing and/or opening of the oven door).
- If these initiatives are unsuccessful, we cannot rule out the need for further write-downs of the value of assets allocated to the Hinges business.

Income statement

€ x 000	<u>H1 2012</u>		<u>H1 2011</u>			<u>FY 2010</u>	
SALES	69,715	100.0%	77,469	100.0%	-10.0%	148,583	100.0%
Materials	(26,762)	-38.4%	(32,662)	-42.2%		(59,103)	-39.8%
Payroll	(15,722)	-22.6%	(16,128)	-20.8%		(30,740)	-20.7%
Change in stock	115	0.2%	3,512	4.5%		910	0.6%
Other operating costs/income	(15,983)	-22.9%	(15,763)	-20.3%		(29,558)	-19.9%
EBITDA	11,363	16.3%	16,428	21.2%	-30.8%	30,092	20.3%
Depreciation	(6,464)	-9.3%	(6,166)	-8.0%		(12,420)	-8.4%
Gains/losses on fixed assets	4	0.0%	4	0.0%		23	0.0%
Impairment of goodwill	0	0.0%	0	0.0%		(1,129)	-0.8%
EBIT	4,903	7.0%	10,266	13.3%	-52.2%	16,566	11.1%
Net financial expense	(541)	-0.8%	(602)	-0.8%		(1,146)	-0.8%
Foreign exchange gains/losses	(96)	-0.1%	160	0.2%		390	0.3%
Equity investments profits/losses	(197)	-0.3%	(143)	-0.2%		(356)	-0.2%
EBT	4,069	5.8%	9,681	12.5%	-58.0%	15,454	10.4%
Income taxes	(1,578)	-2.3%	(3,248)	-4.2%		(4,679)	-3.1%
Minorities	0		0			0	
NET INCOME	2,491	3.6%	6,433	8.3%	-61.3%	10,775	7.3%

Cash flow statement

€ x 1000	H1 2012	H1 2011	FY 11
<i>Cash at the beginning of the period</i>	14,208	9,769	9,769
Net profit	2,491	6,433	10,775
Depreciation	6,464	6,166	12,420
Change in net working capital			
change in inventories	(24)	(2,584)	(801)
change in receivables	790	(3,485)	981
change in payables	(4,279)	3,775	3,623
	(3,513)	(2,294)	3,803
Other changes in operating items	1,170	1,525	(4,559)
Operating cash flow	6,612	11,830	22,439
Investments, net of disposals	(7,366)	(7,643)	(14,455)
Free cash flow	(754)	4,187	7,984
Cash flow from financial activity	(314)	5,108	6,690
Dividends	(6,900)	(9,201)	(9,201)
Forex	(277)	(634)	(1,034)
Cash flow	(8,245)	(540)	4,439
<i>Cash at the end of the period</i>	<i>5,963</i>	<i>9,229</i>	<i>14,208</i>

Balance sheet

€ x 1000	30-Jun-12	31-Dec-11	30-Jun-11
Fixed assets	102,923	102,310	101,770
Net working capital	40,081	37,915	38,322
Capital Employed	143,004	140,225	140,092
Equity	116,657	121,823	118,328
Deferred taxes	367	366	288
Reserves for risks and severance indemnity	3,129	3,240	3,283
Net debt	22,851	14,796	18,193
Sources of finance	143,004	140,225	140,092

Net financial position

€ x 1000	30-Jun-12	31-Dec-11	30-Jun-11
Cash	7	8	9
Positive balances of unrestricted bank accounts	2,398	11,868	7,274
Other liquidities	3,558	2,332	1,946
Cash and cash equivalents (A+B+C)	5,963	14,208	9,229
Current bank overdrafts	16,984	8,546	8,064
Current portion of non-current debt	4,981	8,486	5,903
Other current financial payables	47	33	2
Current financial debt (E+F+G)	22,012	17,065	13,969
Current net financial debt (H-D)	16,049	2,857	4,740
Non-current bank payables	4,565	9,051	9,916
Other non-current financial payables	2,237	2,888	3,537
Non-current financial debt (J+K)	6,802	11,939	13,453
Net financial debt (L+I)	22,851	14,796	18,193

FY 2012 forecasts

- In the second half of the year, the household appliance market in Europe remains negative
- Sabaf management forecasts sales of €135 million for the full year, 10% lower than in 2011
- The EBIT margin for FY2012 is seen in line with that of the first half (7% of sales)

Contact

For further information, please contact our Investor Relations Department

Gianluca Beschi

SABAF S.p.A.

Via dei Carpini, 1

25035 Ospitaletto (Brescia)

Tel +39.030.6843236

gianluca.beschi@sabaf.it

Disclaimer

Certain information included in this document is forward looking and is subject to important risks and uncertainties that could cause actual results to differ materially.

The Company's business is in the domestic appliance industry, with special reference to the gas cooking sector, and its outlook is predominantly based on its interpretation of what it considers to be the key economic factors affecting this business. Forward-looking statements with regard to the Group's business involve a number of important factors that are subject to change, including: the many interrelated factors that affect consumer confidence and worldwide demand for durable goods; general economic conditions in the Group's markets; actions of competitors; commodity prices; interest rates and currency exchange rates; political and civil unrest; and other risks and uncertainties.

Pursuant to Article 154/2, paragraph 2 of the Italian Consolidated Finance Act (Testo Unico della Finanza), the company's Financial Reporting Officer Alberto Bartoli declares that the financial disclosure contained in this financial presentation corresponds to the company's records, books and accounting entries.